



**AMERICAN  
FORGE & FOUNDRY**

**Professional Products.  
Professional Results.**





**AMERICANFORGE&FOUNDRY™**

**PROFESSIONAL PRODUCTS. PROFESSIONAL RESULTS.**

Established in 1963, American Forge & Foundry has built a long-standing tradition of providing quality products, innovative safety solutions, exceptional service, and value. Available through our network of distributor partners, AFF can be found in numerous heavy-duty industries, automotive repair shops, military sectors, agriculture, and other demanding businesses. We continually challenge ourselves to expand or improve our product portfolio to always meet the needs of the professional worker, and get them home safely at the end of each day.

In 2017, American Forge & Foundry, Inc. joined with the Sellstrom Manufacturing Company to form SureWerx USA. Headquartered in a new state of the art facility in Elgin, Illinois our tool and safety portfolio now include the following brands:

**Tools and Equipment USA:**

- American Forge & Foundry® Hydraulic Lifting Equipment, Shop Equipment, and Lubrication

**Safety Products USA:**

















- Sellstrom® Personal Protective Equipment and Welding
- Jackson Safety® Personal Protective Equipment and Welding
- PeakWorks® Fall Protection
- Pioneer® Safety Apparel
- KneePro Knee and Elbow Protection

Thank you for your business and as always...work safe!

To contact our customer service team:

Email: [orders.usa@surewerx.com](mailto:orders.usa@surewerx.com)  
 Phone: 800-323-7402  
 Fax: 847-717-8419  
[affjaxx.com](http://affjaxx.com)  
[surewerx.com](http://surewerx.com)

*SureWerx™ has made every effort to provide accurate and up-to-date features, specifications and photos of our products for your information. SureWerx™ reserves the right to make changes in design, appearance and construction of any and all products listed herein without incurring any obligation in making such changes in products previously sold or transferred. We reserve the right to discontinue the availability of any products at such time we deem necessary.*

Category	Product Example	Pages	Category	Product Example	Pages
Floor Jacks		4-9	Shop Presses		36-39
Long Chassis Jacks		10-11	Shop Equipment		40-45
Axle Jacks		12-13	Engine Cranes and Stands		46-48
Transmission Jacks		14-19	Material Handling		49-51
Specialty Jacks		20-23	Hand Tools and Accessories		52-61
Bottle Jacks		24-26	Air Tools		62-65
Air Lifts		27	Lubrication		66-76
Safety Stands		28-31	Merchandising		77-87
Wheel Dollies		32	Viking		88
Power Rams		33-35			



American Forge & Foundry offers floor jacks from 2 to 4 ton and most have the option of a 1 or 2 pc handle. They are designed with the professional service technician in mind and built to withstand the rigors of everyday use. Heavy gauge steel, double pumper technology, UV powder coat paint, upgraded seals, and an overload safety valve are just some of the features that make the AFF floor jacks among the most durable in the industry today.

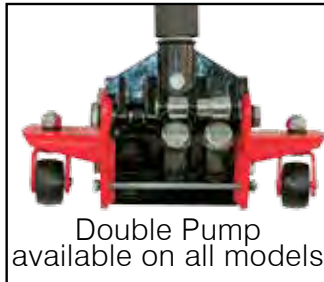

Double Pump available on all models

### 2 TON LOW PROFILE FLOOR JACK

#### MODEL 200T

- Super low pickup height of 2-3/4" offers ideal access to custom vehicles
- Twin hydraulic system maximizes speed and provides additional strength
- Universal joint technology and precision release valve offers a more controlled release
- Tough UV powder coated frame for greater protection and durability
- Pinned steel saddle with rubber pad for added vehicle protection
- One piece foam covered 50" handle.
- Constructed with safety valve to prevent overloading



MODEL	CAPACITY (Tons)	LOW HEIGHT	HIGH HEIGHT	CHASSIS LENGTH	OVERALL WIDTH (front)	OVERALL WIDTH (rear)	SHIP WEIGHT
200T	2	2.75"	20"	27"	11.75"	15"	99 lbs

### 2 TON LOW PROFILE FLOOR JACK

#### MODEL 202T

- Super low pickup height of 2-3/4" offers ideal access to custom vehicles
- Twin hydraulic system maximizes speed and provides additional strength
- Universal joint technology and precision release valve offers a more controlled release
- Tough UV powder coated frame for greater protection and durability
- Pinned steel saddle with rubber pad for added vehicle protection
- Two piece foam covered 50" handle for easy portability and storage
- Constructed with safety valve to prevent overloading
- Includes 2 pc handle for easy storage



MODEL	CAPACITY (Tons)	LOW HEIGHT	HIGH HEIGHT	CHASSIS LENGTH	OVERALL WIDTH (front)	OVERALL WIDTH (rear)	SHIP WEIGHT
202T	2	2.75"	20"	27"	11.75"	15"	99 lbs

### 2.5 TON PROFESSIONAL HEAVY DUTY FLOOR JACK

#### MODEL 320SS

- Twin hydraulic system maximizes speed and provides additional strength
- Universal joint technology and precision release valve offers a more controlled release
- Tough UV powder coated frame for greater protection and durability
- Pinned steel saddle with rubber pad for added vehicle protection
- One piece foam covered 50" handle
- Features safety valve to prevent overloading



MODEL	CAPACITY (Tons)	LOW HEIGHT	HIGH HEIGHT	CHASSIS LENGTH	OVERALL WIDTH (front)	OVERALL WIDTH (rear)	SHIP WEIGHT
320SS	2.5	5"	21"	28.5"	9"	13.5"	101 lbs

### 2.5 TON PROFESSIONAL HEAVY DUTY FLOOR JACK

#### MODEL 322SS

- Twin hydraulic system maximizes speed and provides additional strength
- Universal joint technology and precision release valve offers a more controlled release
- Tough UV powder coated frame for greater protection and durability
- Pinned steel saddle with rubber pad for added vehicle protection
- Two piece foam covered 50" handle for easy portability and storage
- Features safety valve to prevent overloading
- Includes 2 pc handle for easy storage



MODEL	CAPACITY (Tons)	LOW HEIGHT	HIGH HEIGHT	CHASSIS LENGTH	OVERALL WIDTH (front)	OVERALL WIDTH (rear)	SHIP WEIGHT
322SS	2.5	5"	21"	28.5"	9"	13.5"	106 lbs

### 3 TON LOW RIDER FLOOR JACK

#### MODEL 300LR

- Twin hydraulic system for fast and efficient lifting
- Heavy duty pump, ram, and cylinders are precision machined and inspected to ensure long service life
- High grade U-cups seals and high-pressure plunger for maximum performance
- Rear mounted swivel casters for easy maneuverability
- Universal joint technology provides a more controlled descent
- Pinned and padded saddle for extra vehicle protection
- Flanged side plates for increased stability
- Integrated parts tray keeps small components from getting lost
- Meets ASME 2014 standards
- Includes 2 pc handle for easy storage



**NEW PRODUCT!**



MODEL	CAPACITY (Tons)	LOW HEIGHT	HIGH HEIGHT	CHASSIS LENGTH	OVERALL WIDTH (front)	OVERALL WIDTH (rear)	SHIP WEIGHT
300LR	3	3.74"	20.5"	28.34"	11.22"	14.96"	95 lbs



### 3 TON PROFESSIONAL HEAVY DUTY FLOOR JACK

#### MODEL 300T

- Low pick up height of 3.75"
- Twin hydraulic system maximizes speed and provides additional strength
- Universal joint technology and precision release valve offers a more controlled release
- Tough UV powder coated frame for greater protection and durability
- Pinned steel saddle with rubber pad for added vehicle protection
- One piece foam covered 50" handle
- Plungers use a U Cup design for more efficient seal
- Constructed with safety valve to prevent overloading

MODEL	CAPACITY (Tons)	LOW HEIGHT	HIGH HEIGHT	CHASSIS LENGTH	OVERALL WIDTH (front)	OVERALL WIDTH (rear)	SHIP WEIGHT
300T	3	3.75"	21.5"	30.75"	11.38"	14.5"	104 lbs



### 3 TON PROFESSIONAL HEAVY DUTY FLOOR JACK

#### MODEL 302T

- Low pick up height of 3.75"
- Twin hydraulic system maximizes speed and provides additional strength
- Universal joint technology and precision release valve offers a more controlled release
- Tough UV powder coated frame for greater protection and durability
- Pinned steel saddle with rubber pad for added vehicle protection
- Two piece foam covered 50" handle for easy portability and storage
- Plungers use a U Cup design for more efficient seal
- Constructed with safety valve to prevent overloading
- Includes 2 pc handle for easy storage



MODEL	CAPACITY (Tons)	LOW HEIGHT	HIGH HEIGHT	CHASSIS LENGTH	OVERALL WIDTH (front)	OVERALL WIDTH (rear)	SHIP WEIGHT
302T	3	3.75"	21.5"	30.75"	11.38"	14.5"	109 lbs

### 3.5 TON PROFESSIONAL HEAVY DUTY FLOOR JACK

#### MODEL 350SS

- Twin hydraulic system maximizes speed and provides additional strength
- Universal joint technology and precision release valve offers a more controlled release
- Tough UV powder coated frame for greater protection and durability
- Pinned steel saddle with rubber pad for added vehicle protection
- Rear mounted 2.75" swivel casters for ease of maneuverability
- One piece foam covered 50" handle
- Features safety valve to prevent overloading

MODEL	CAPACITY (Tons)	LOW HEIGHT	HIGH HEIGHT	CHASSIS LENGTH	OVERALL WIDTH (front)	OVERALL WIDTH (rear)	SHIP WEIGHT
350SS	3-1/2	4"	19.5"	29"	11.25"	15"	119 lbs



### 3.5 TON PROFESSIONAL HEAVY DUTY FLOOR JACK

#### MODEL 352SS

- Twin hydraulic system maximizes speed and provides additional strength
- Universal joint technology and precision release valve offers a more controlled release
- Tough UV powder coated frame for greater protection and durability
- Pinned steel saddle with rubber pad for added vehicle protection
- Rear mounted 2.75" swivel casters for ease of maneuverability
- Two piece foam covered 50" handle for easy portability and storage
- Features safety valve to prevent overloading
- Includes 2 pc handle for easy storage



MODEL	CAPACITY (Tons)	LOW HEIGHT	HIGH HEIGHT	CHASSIS LENGTH	OVERALL WIDTH (front)	OVERALL WIDTH (rear)	SHIP WEIGHT
352SS	3-1/2	4"	19.5"	29"	11.25"	15"	124 lbs

### 4 TON HEAVY DUTY FLOOR JACK

#### MODEL 400SS

- Twin hydraulic system for fast and efficient lifting
- Heavy duty pump, ram, and cylinders are precision machined and inspected to ensure long service life
- High grade U-cups seals and high-pressure plunger for maximum performance
- Rear mounted swivel casters for easy maneuverability
- Universal joint technology provides a more controlled descent
- Pinned and padded saddle for extra vehicle protection
- Flanged side plates for increased stability
- Integrated parts tray keeps small components from getting lost
- Meets ASME 2014 standards
- Includes 2 pc handle for easy storage



MODEL	CAPACITY (Tons)	LOW HEIGHT	HIGH HEIGHT	CHASSIS LENGTH	OVERALL WIDTH (front)	OVERALL WIDTH (rear)	SHIP WEIGHT
400SS	4	4.30"	20.5"	28.82"	10.82"	14.33"	105 lbs



**1.5 TON WRECKER SERVICE JACK**

**MODEL 206**

- Lightweight anodized aluminum frame
- Polished plunger pistons provide a smooth surface for longer seal life
- Wiper seals prevent dirt from entering hydraulic system
- Twin hydraulic system for faster and easier lifts
- Additional machining to ensure the tightest tolerances
- Front roller and a single side handle for easy portability
- Padded 2 pc handle



MODEL	CAPACITY (Tons)	LOW HEIGHT	HIGH HEIGHT	CHASSIS LENGTH	OVERALL WIDTH (front)	OVERALL WIDTH (rear)	SHIP WEIGHT
206	1.5	3.25"	15"	20"	6"	10"	30 lbs

**2 TON WRECKER SERVICE JACK**

**MODEL 208**

- Lightweight anodized aluminum frame
- Polished plunger pistons provide a smooth surface for longer seal life
- Wiper seals prevent dirt from entering hydraulic system
- Twin hydraulic system for faster and easier lifts
- Additional machining to ensure the tightest tolerances
- Two side handles for easy portability
- Padded 2 pc handle



MODEL	CAPACITY (Tons)	LOW HEIGHT	HIGH HEIGHT	CHASSIS LENGTH	OVERALL WIDTH (front)	OVERALL WIDTH (rear)	SHIP WEIGHT
208	2	3.5"	18.5"	24.5"	10.75"	11.5"	47 lbs

**3 TON WRECKER SERVICE JACK**

**MODEL 210**

- Lightweight anodized aluminum frame
- Polished plunger pistons provide a smooth surface for longer seal life
- Wiper seals prevent dirt from entering hydraulic system
- Twin hydraulic system for faster and easier lifts
- Additional machining to ensure the tightest tolerances
- Two side handles for easy portability
- Padded 2 pc handle



MODEL	CAPACITY (Tons)	LOW HEIGHT	HIGH HEIGHT	CHASSIS LENGTH	OVERALL WIDTH (front)	OVERALL WIDTH (rear)	SHIP WEIGHT
210	3	3.75"	19.5"	26"	11.5"	13.5"	58 lbs

**Floor Jack Accessories**

**750 LB. CAPACITY TRANSMISSION ADAPTER HEAD**

**MODEL 3165**

Converts any AFF or Viking floor jack to remove and install automobile transmissions, transfer cases and differentials.

- Saddle is 19.5" wide
- 30° front tilt and 15° back tilt.
- Ship weight 28 lbs.



**CROSSBEAM ADAPTER**

**MODEL 3167**

Use any AFF or Viking floor jacks with a 1/1-8" diameter saddle stud to lift the entire front or rear of a vehicle.

- 4,400 lb. capacity
- Two telescopic 4.75" x 4.75" rubber saddle pads for added vehicle protection easily adjust to a maximum 38" width
- Ship weight 31 lbs.



**FLOOR JACK HANDLE**

**MODEL 390**

- Protects vehicle from dings and scrapes
- Made of solvent resistant high impact plastic
- Air filled end cap provides additional protection
- Inexpensive insurance for car finishes.
- Works on many other shop tools such as bead breakers and press handles
- Ship weight 1lb.



**REPLACEMENT SADDLE PAD**

**MODEL 200TK42**

- Fits Models 200T & 202T
- Saddle diameter 5-3/8"
- Ship weight 1 lb



**Floor Jack Replacement Parts**

**REPLACEMENT SADDLE PAD**

**MODEL 350GTK41**

- Fits all AFF Model 350 series floor jacks
- Saddle diameter 5-1/2"
- Ship weight 1 lb



**REPLACEMENT FOAM HANDLE COVER**

**MODEL 350GTK23**

- Fits all AFF Model 350 series floor jacks
- Ship weight 7 lbs

**REPLACEMENT FOAM HANDLE COVER**

**MODEL 200TK40**

- Fits all AFF Model 200T Floor Jack
- Ship weight 7 lbs

**ONE PIECE HANDLE**

**MODEL 350SSK24**

- Fits Models 200T, 300T, and 350SS
- Ship weight 8 lbs

**TWO PIECE HANDLE**

**MODEL 352SSK24**

- Fits Models 202T, 302T, and 352SS
- Ship weight 8 lbs



Call AFF for complete list of parts



American Forge & Foundry's Long Chassis Service Jacks are designed for heavy lift applications where added reach and access is also necessary. Applications include bus and truck fleets, agriculture, industrial, military bases, and job sites. All air assisted service jacks can be operated manually when shop air is not available.

**5 TON CAPACITY HEAVY DUTY MANUAL HYDRAULIC LONG CHASSIS JACK**

**MODEL 3120**

- Heavy duty pumps, rams, and cylinders are precision machined and inspected to ensure long service life and superior performance
- Super long 56" body for easier lifting of vehicles with long overhangs
- Foot operated pump for quick lifting efficiency
- Handle mounted locking control lever has 3 positions for better versatility in under car positioning
- Automatic overload safety valves for added safety

MODEL	CAPACITY (Tons)	LOW HEIGHT	HIGH HEIGHT	CHASSIS LENGTH	OVERALL WIDTH (front)	OVERALL WIDTH (rear)	SHIP WEIGHT
3120	5	6"	22.5"	56"	11.5"	15"	254 lbs



Manual Hydraulic

**5 TON CAPACITY HEAVY DUTY AIR/HYDRAULIC LONG CHASSIS JACK**

**MODEL 3125**

- Operates at 115-200 PSI / 7.8 cubic feet per minute
- Heavy duty pumps, rams, and cylinders are precision machined and inspected to ensure long service life and superior performance
- Super long 56" body for easier lifting of vehicles with long overhangs
- Foot operated pump for quick lifting efficiency
- Handle mounted locking control lever has 3 positions for better versatility in under car positioning
- Automatic overload safety valves for added safety

MODEL	CAPACITY (Tons)	LOW HEIGHT	HIGH HEIGHT	CHASSIS LENGTH	OVERALL WIDTH (front)	OVERALL WIDTH (rear)	SHIP WEIGHT
3125	5	6"	22.5"	56"	11.5"	15"	273 lbs



Air Assist

**10 TON CAPACITY HEAVY DUTY MANUAL HYDRAULIC LONG CHASSIS JACK**

**MODEL 3130**

- Heavy duty pumps, rams, and cylinders are precision machined and inspected to ensure long service life and superior performance
- Super long 61" body for easier lifting of vehicles with long overhangs
- Foot operated pump for quick lifting efficiency
- Handle mounted locking control lever has 3 positions for better versatility in under car positioning
- Automatic overload safety valves for added safety

MODEL	CAPACITY (Tons)	LOW HEIGHT	HIGH HEIGHT	CHASSIS LENGTH	OVERALL WIDTH (front)	OVERALL WIDTH (rear)	SHIP WEIGHT
3130	10	7"	23"	61"	13"	18"	366 lbs



Manual Hydraulic

**10 TON CAPACITY HEAVY DUTY AIR/HYDRAULIC LONG CHASSIS JACK**

**MODEL 3135**

- Operates at 115-200 PSI / 7.8 cubic feet per minute
- Heavy duty pumps, rams, and cylinders are precision machined and inspected to ensure long service life and superior performance
- Super long 61" body for easier lifting of vehicles with long overhangs
- Foot operated pump for quick lifting efficiency
- Handle mounted locking control lever has 3 positions for better versatility in under car positioning
- Automatic overload safety valves for added safety

MODEL	CAPACITY (Tons)	LOW HEIGHT	HIGH HEIGHT	CHASSIS LENGTH	OVERALL WIDTH (front)	OVERALL WIDTH (rear)	SHIP WEIGHT
3135	10	7"	23"	61"	13"	18"	387 lbs



Air Assist

**20 TON CAPACITY HEAVY DUTY MANUAL HYDRAULIC LONG CHASSIS JACK**

**MODEL 3220**

- Heavy duty pumps, rams, and cylinders are precision machined and inspected to ensure long service life and superior performance
- Super long 66" body for easier lifting of vehicles with long overhangs
- Foot operated pump for quick lifting efficiency
- Handle mounted locking control lever has 3 positions for better versatility in under car positioning
- Automatic overload safety valves for added safety

MODEL	CAPACITY (Tons)	LOW HEIGHT	HIGH HEIGHT	LENGTH	FRONT WIDTH	REAR WIDTH	SHIP WEIGHT
3220	20	7.50"	26.37"	66.00"	13.80"	19.70"	530 lbs



Manual Hydraulic

**20 TON CAPACITY HEAVY DUTY AIR/HYDRAULIC LONG CHASSIS JACK**

**MODEL 3225**

- Uses 2.25 cubic ft / min of compressed air at 100 PSI
- Heavy duty pumps, rams, and cylinders are precision machined and inspected to ensure long service life and superior performance
- Super long 66" body for easier lifting of vehicles with long overhangs
- Foot operated pump for quick lifting efficiency
- Handle mounted locking control lever has 3 positions for better versatility in under car positioning
- Automatic overload safety valves for added safety

MODEL	CAPACITY (Tons)	LOW HEIGHT	HIGH HEIGHT	LENGTH	FRONT WIDTH	REAR WIDTH	SHIP WEIGHT
3225	20	7.50"	26.37"	66.00"	13.80"	19.70"	562 lbs



Air Assist



American Forge & Foundry's Axle Jacks are engineered to withstand the extreme conditions of all heavy duty applications including roadside service, fleet maintenance, agriculture, military sectors, and much more.

### 22 TON SINGLE STAGE AIR/HYDRAULIC AXLE JACK

#### MODEL 565E (2 pc. handle) MODEL 565E1 (1 pc. handle)

- Pump, ram, and cylinders are precision machined and inspected to ensure long service life and superior performance
- Corrosion resistant aluminum and nylon composite air motor
- Unique motor design advances ram to load faster for quick and more efficient operation
- Air assisted lowering and dual return springs provide controlled and easy descent
- Large 7-3/4" rear wheels for easy positioning and smooth motion
- Includes 3 heat treated extensions (3/4", 2-3/4", and 4") for a wide range of lifting options
- Safety overload system prevents jack from being used beyond its rated capacity
- Operates at 90-180 PSI



3 pc. adapter kit included as standard accessory



### ONE-PIECE "T" HANDLE

#### MODEL 565E-HANDLE

This kit is for those who want to replace the 2-piece handle on their 565E 22-ton axle jack  
Ship weight 14 lbs.

MODEL	CAPACITY (Tons)	RAM LIFT	LOW HEIGHT	HIGH HEIGHT	REACH	WIDTH	SHIP WEIGHT
565E	22	4.75"	8.75"	21.5"	61"	13"	107 lbs
565E1	22	4.75"	8.75"	21.5"	61"	13"	107 lbs

### 35 TON AIR/HYDRAULIC AXLE JACK

#### MODEL 535A

- Ideal for lifting trucks, buses, trailers, and other heavy duty equipment
- Can be operated with air (90-180 PSI) or manually
- Heat treated pistons for maximum strength
- Heavy duty steel saddle for secure lifts
- 55" length for easy access to hard to reach lift points
- Convenient carrying handle for easier transportation
- Safety overload system prevents jack from being used beyond its rated capacity



MODEL	CAPACITY (Tons)	RAM LIFT	LOW HEIGHT	HIGH HEIGHT	REACH	WIDTH	SHIP WEIGHT
535A	35	5.75"	11"	21.25"	55"	9"	101 lbs

### 35 TON SINGLE STAGE AIR/HYDRAULIC AXLE JACK

#### MODEL 536

- Pump, ram, and cylinders are precision machined and inspected to ensure long service life and superior performance
- Corrosion resistant aluminum and nylon composite air motor
- Unique motor design advances ram to load faster for quick and more efficient operation
- Air assisted lowering and dual return springs provide controlled and easy descent
- Large 8-5/8" rear wheels for easy positioning and smooth motion
- Includes 3 heat treated extensions (3/4", 2-3/4", and 4") for a wide range of lifting options
- Safety overload system prevents jack from being used beyond its rated capacity
- Includes 2 pc handle
- Operates at 90-180 PSI

MODEL	CAPACITY (Tons)	RAM LIFT	LOW HEIGHT	HIGH HEIGHT	REACH	WIDTH	SHIP WEIGHT
536	35	4.5"	10.625"	23"	58"	12.5"	110 lbs



### 50 TON SINGLE STAGE AIR/HYDRAULIC AXLE JACK

#### MODEL 551

- Pump, ram, and cylinders are precision machined and inspected to ensure long service life and superior performance
- Corrosion resistant aluminum and nylon composite air motor
- Unique motor design advances ram to load faster for quick and more efficient operation
- Air assisted lowering and dual return springs provide controlled and easy descent
- Large 8-5/8" rear wheels for easy positioning and smooth motion
- Includes 3 heat treated extensions (3/4", 2-3/4", and 4") for a wide range of lifting options
- Safety overload system prevents jack from being used beyond its rated capacity
- Includes 1 pc handle
- Operates at 90-180 PSI

MODEL	CAPACITY (Tons)	RAM LIFT	LOW HEIGHT	HIGH HEIGHT	REACH	WIDTH	SHIP WEIGHT
551	50	5.75"	12.375"	26.5"	65"	14.5"	158 lbs





American Forge & Foundry's Transmission Jacks provide the service technician the capability for "one-man" removal and installation of bulk transmissions, differentials, transfer cases, fuel tanks, and more. AFF offers telescoping, low profile, and high lift styles in both manual hydraulic and air assist.

**1,100 LB CAPACITY TELESCOPIC MANUAL TRANSMISSION JACK**

**MODEL 3052**

- Two stage telescopic ram designed for medium duty truck transmissions, transfer cases, and differentials
- Double pump hydraulic system for quick lift operation
- Powder coat finish provides resistance to corrosion, chemicals, and scratches
- Chrome plated pump core and piston rod reduces friction and provides long service life
- Adjustable saddle with corner bracket and safety chain
- Optional Fuel Tank Adapter (Model 3198) available. Includes safety straps and grounding cables.
- Adheres to ASME 2014

**NEW PRODUCT!**

**2 Stage Manual**



MODEL	OPERATION	CAPACITY (LBS)	RAM STAGES	LOW HEIGHT	HIGH HEIGHT	FRONT TILT	REAR TILT	BASE WIDTH	SHIP WEIGHT
3052	Manual	1100	2	37"	78"	28°	49°	28"X 32"	161 lbs

**1,100 LB CAPACITY TELESCOPIC AIR ASSIST TRANSMISSION JACK**

**MODEL 3052A**

- Two stage telescopic ram designed for medium duty truck transmissions, transfer cases, and differentials
- Double pump hydraulic system for quick lift operation
- Powder coat finish provides resistance to corrosion, chemicals, and scratches
- Chrome plated pump core and piston rod reduces friction and provides long service life
- Adjustable saddle with corner bracket and safety chain
- Optional Fuel Tank Adapter (Model 3198) available. Includes safety straps and grounding cables.
- Adheres to ASME 2014

**NEW PRODUCT!**

**2 Stage Air Assist**



MODEL	OPERATION	CAPACITY (LBS)	RAM STAGES	LOW HEIGHT	HIGH HEIGHT	FRONT TILT	REAR TILT	BASE WIDTH	SHIP WEIGHT
3052A	Air Assist	1100	2	37"	78"	28°	49°	28"X 32"	170 lbs

**2,000 LB CAPACITY TELESCOPIC MANUAL TRANSMISSION JACK**

**MODEL 3102**

- Two stage telescopic ram designed for medium duty truck transmissions, transfer cases, and differentials
- Double pump hydraulic system for quick lift operation
- Powder coat finish provides resistance to corrosion, chemicals, and scratches
- Chrome plated pump core and piston rod reduces friction and provides long service life
- Adjustable saddle with corner bracket and safety chain
- Optional Fuel Tank Adapter (Model 3198) available. Includes safety straps and grounding cables.
- Adheres to ASME 2014

**NEW PRODUCT!**

**2 Stage Manual**



MODEL	OPERATION	CAPACITY (LBS)	RAM STAGES	LOW HEIGHT	HIGH HEIGHT	FRONT TILT	REAR TILT	BASE WIDTH	SHIP WEIGHT
3102	Manual	2000	2	37"	76"	28°	49°	28"X 32"	174 lbs

**2,000 LB CAPACITY TELESCOPIC AIR ASSIST TRANSMISSION JACK**

**MODEL 3102A**

- Two stage telescopic ram designed for medium duty truck transmissions, transfer cases, and differentials
- Double pump hydraulic system for quick lift operation
- Powder coat finish provides resistance to corrosion, chemicals, and scratches
- Chrome plated pump core and piston rod reduces friction and provides long service life
- Adjustable saddle with corner bracket and safety chain
- Optional Fuel Tank Adapter (Model 3198) available. Includes safety straps and grounding cables.
- Adheres to ASME 2014

**NEW PRODUCT!**

**2 Stage Air Assist**



MODEL	OPERATION	CAPACITY (LBS)	RAM STAGES	LOW HEIGHT	HIGH HEIGHT	FRONT TILT	REAR TILT	BASE WIDTH	SHIP WEIGHT
3102A	Air Assist	2000	2	37"	76"	28°	49°	28"X 32"	183 lbs



**700 LB. CAPACITY TELESCOPIC TRANSMISSION JACK**

**MODEL 2145A**

- Economical single stage ram design
- Adjustable saddle
- Large 360° swivel casters for smooth transportation
- Safety overload system prevents jack from being used beyond its rated capacity



Single Stage Manual

MODEL	CAPACITY (LBS)	RAM STAGES	LOW HEIGHT	HIGH HEIGHT	FRONT TILT	REAR TILT	SIDE TILT	HEAD WIDTH	HEAD LENGTH	BASE WIDTH	SHIP WEIGHT
2145	700	1	53"	73"	12°	12°	NA	10"-14"	10"-14"	39"x 39"	95 lbs

**1/2 TON-1100 LB CAPACITY TELESCOPIC TRANSMISSION JACK**

**MODEL 2158**

- Universal head provides forward, back, and side tilt
- Extra wide base provide easier and more efficient under hoist positioning
- Foot operated pump frees both hands for easier alignment
- Convenient release knob for easy and controlled descent
- Safety overload system prevents jack from being used beyond its rated capacity



Single Stage Manual

MODEL	CAPACITY (LBS)	RAM STAGES	LOW HEIGHT	HIGH HEIGHT	FRONT TILT	REAR TILT	SIDE TILT	HEAD WIDTH	HEAD LENGTH	BASE WIDTH	SHIP WEIGHT
2158	1100	1	45"	71"	30°	15°	NA	8-14"	14"	23"x 23"	103 lbs

**450 LB. CAPACITY TRANSMISSION JACK**

**MODEL 3160**

- Adjustable head for easier positioning and alignment
- Nylon safety strap to secure load
- Requires 1/2" drive ratchet (not included)
- 450 lb. capacity
- Height: 7.25" - 22.5"
- Ship weight 43 lbs.



**1/2 TON-1200 LB CAPACITY LOW PROFILE TRANSMISSION JACK**

**MODEL 3171**

- Designed for light truck transmissions
- Fully adjustable universal saddle with corner brackets and safety chains
- Safety overload bypass to prevent hydraulic damage
- 24" handle pivots 360° around pump



MODEL	CAPACITY (LBS)	LOW HEIGHT	HIGH HEIGHT	FRONT TILT	REAR TILT	SIDE TILT	HEAD WIDTH	HEAD LENGTH	WIDTH	LENGTH	SHIP WEIGHT
3171	1200	6.875"	31.75"	15°	12°	15°	7"-13"	8"-11"	19.75"	38.25"	117 lbs

**1 TON CAPACITY-2000 LB LOW PROFILE TRANSMISSION JACK**

**MODEL 3172**

- Designed for light truck transmissions
- Fully adjustable universal saddle with corner brackets and safety chains
- Safety overload bypass to prevent hydraulic damage
- 24" handle pivots 360° around pump
- Four industrial grade 3" casters



MODEL	CAPACITY (LBS)	LOW HEIGHT	HIGH HEIGHT	FRONT TILT	REAR TILT	SIDE TILT	HEAD WIDTH	HEAD LENGTH	WIDTH	LENGTH	SHIP WEIGHT
3172	2000	5.875"	30.75"	15°	10°	15°	7"-16"	9"-14"	18.25"	36.75"	145 lbs

**1 TON-2000 LB CAPACITY HEAVY DUTY TRANSMISSION JACK**

**MODEL 3178**

- Adjustable width head plate and wedge shaped brackets allows for a wide range of mounting options
- 4-way tilting head allows easier removal and installation of transmissions
- Equipped with a 360° swivel handle for better use in confined areas
- Open leg design for added versatility
- Safety chain included
- Rugged heavy duty casters
- Safety overload system prevents jack from being used beyond its rated capacity



MODEL	CAPACITY (LBS)	LOW HEIGHT	HIGH HEIGHT	FRONT TILT	REAR TILT	SIDE TILT	HEAD WIDTH	HEAD LENGTH	WIDTH	LENGTH	SHIP WEIGHT
3178	2000	6.5"	31.5"	79°	9°	10-18°	18.25"	18.25"	28"	48"	335 lbs



**2 TON-4400 LB CAPACITY HEAVY DUTY TRANSMISSION JACK**

**MODEL 3180A**

- The only Heavy Duty transmission jack with a rated capacity of over 2 tons
- 8.5" low height provide additional low profile solutions
- Fully adjustable saddle with maximum tilt for easier alignment
- Adjustable corner brackets provide extra versatility
- Extra-long 32" handle rotates 360° around pump
- Rugged industrial grade 4" casters for smooth transportation and easy mobility
- Convenient side tray to store small tools and parts
- Safety chain included
- Safety overload system prevents jack from being used beyond its rated capacity



MODEL	CAPACITY (LBS)	LOW HEIGHT	HIGH HEIGHT	FRONT TILT	REAR TILT	SIDE TILT	HEAD WIDTH	HEAD LENGTH	WIDTH	LENGTH	SHIP WEIGHT
3180A	4400	8.5"	34"	15°	30°	12°	12"-18"	16"-20"	26"	43"	374 lbs

**TRANSMISSION JACK ADAPTER SET**

**MODEL 3181**

- Ideal for use with AFF's model 3180A Heavy Duty Transmission Jack
- Works with a wide variety of different truck transmissions including Eaton® and Fuller®
- Comes with 6 adapter bars (4 small, 2 large) 4 positioning screws, and 2 securing chains



**FUEL TANK ADAPTER**

**MODEL 3198**

Converts AFF Model 3052, 3052A, 3102, and 3102A transmission jacks to remove and install fuel tanks.

- 4" x 5.75" diameter saddles adjust from 19.75" to 31.75"
- Includes two safety straps and two grounding cables.
- 80 lb. capacity
- Ship weight 59 lbs



**2,500 LB Capacity Power Train Lift/Table**

**MODEL 3182**

This lift handles transmissions and fuel tanks as well as engines, transaxles, large electric vehicle batteries, and more. It also serves as a work table where components can be lowered to a stable and secure work height for on-site repair.

- Safety latches at 30%, 50%, and 80% of max height provides additional operator safety
- Air assist foot pump with 9' extension allows access anywhere around the work area and provides hands free operation
- Scissor lift design allows access to all four sides of the component
- Table top height from 33" to over 77"
- 2 heavy duty ratchet tie downs are included to safely secure the load
- 8" diameter swivel casters for easy maneuverability
- Rear wheels can be locked to prevent rolling.
- Safety overload system prevents lift from being used beyond the load limiting standard
- Meets current ASME/PALD



**NEW PRODUCT!**



Lowered Position

MODEL	Capacity (LBS)	Low Lift Height	High Lift Height	Overall Length	Overall Width	Overall Height	Table Size	Table Tilt	SHIP WEIGHT
3182	2,500	33 "	77"	48"	33"	33"	20"x30"	+/-10°	625 lbs



American Forge & Foundry features a wide range of specialty jacks for the trucking, agriculture, fleet, and military sectors. Each is designed for applications where extra capacity, added reach, or height may be required.

**25/10 TON TWO STAGE AIR/HYDRAULIC AXLE JACK**

**MODEL 546SD**

- Descent metering valve allows for a safe and controlled lowering of the load
- Extra-long 54" handle can be locked in 3 positions for easy placement in confined areas
- Single piece base construction provides superior strength for increased load stability
- Includes 1.75" and 3" extensions and saddle adapter
- Double polished chrome pistons provide tighter tolerances and greater hydraulic seal
- Safety overload system prevents jack from being used beyond its rated capacity



MODEL	CAPACITY (Tons)	RAM LIFT	LOW HEIGHT	HIGH HEIGHT	HIGH HEIGHT With Extensions	WORKING AIR PRESSURE	SHIP WEIGHT
546SD	25	3.82"	7.28"	11.10"	16.85"	116 to 174 PSI	128 lbs
	10	7.56"	7.28"	14.84"	20.59"		

**30/15 TON TWO STAGE AIR/HYDRAULIC AXLE JACK**

**MODEL 545SD**

- Lightweight design ideal for the Service Vehicle industry
- Ideal for drop axles and other low clearance applications
- Extra-long removable handle and rugged casters for easy positioning
- Descent metering valve allows for a safe and controlled lowering of the load
- Includes 1.75" and 3" extensions and saddle adapter
- Double polished chrome pistons provide tighter tolerances and greater hydraulic seal
- Safety overload system prevents jack from being used beyond its rated capacity



MODEL	CAPACITY (Tons)	RAM LIFT	LOW HEIGHT	HIGH HEIGHT	HIGH HEIGHT With Extensions	WORKING AIR PRESSURE	SHIP WEIGHT
546SD	30	2.91"	5.92"	8.82"	14.57"	116 to 145 PSI	77 lbs
	15	5.59"	5.92"	11.50"	17.25"		

**50/25 TON TWO STAGE AIR/HYDRAULIC AXLE JACK**

**MODEL 547SD**

- 50 ton stage built for the rigors of the Heavy Duty, Fleet, Agriculture, and Military sectors
- Extra-long 54" handle can be locked in 3 positions for easy placement in confined areas
- Single piece base construction provides superior strength for increased load stability
- Descent metering valve allows for a safe and controlled lowering of the load
- Includes 1.75" and 3" extensions and saddle adapter
- Double polished chrome pistons provide tighter tolerances and greater hydraulic seal
- Safety overload system prevents jack from being used beyond its rated capacity



MODEL	CAPACITY (Tons)	RAM LIFT	LOW HEIGHT	HIGH HEIGHT	HIGH HEIGHT With Extensions	WORKING AIR PRESSURE	SHIP WEIGHT
547SD	50	4.61"	8.46"	13.07"	18.82"	116 to 174 PSI	165 lbs
	25	9.09"	8.46"	17.56"	23.31"		

**60/40/20 TON THREE STAGE AIR/HYDRAULIC AXLE JACK**

**MODEL 548SD**

- 60 ton stage built for the rigors of the Heavy Duty, Fleet, Agriculture, and Military sectors
- Extra-long 54" handle can be locked in 3 positions for easy placement in confined areas
- Single piece base construction provides superior strength for increased load stability
- Descent metering valve allows for a safe and controlled lowering of the load
- Includes 1.75" and 3" extensions and saddle adapter
- Double polished chrome pistons provide tighter tolerances and greater hydraulic seal
- Safety overload system prevents jack from being used beyond its rated capacity



MODEL	CAPACITY (Tons)	RAM LIFT	LOW HEIGHT	HIGH HEIGHT	HIGH HEIGHT With Extensions	WORKING AIR PRESSURE	SHIP WEIGHT
548SD	60	3.03"	6.89"	9.92"	15.67"	116 to 174 PSI	165 lbs
	40	5.79"	6.89"	12.68"	18.43"		
	20	9.02"	6.89"	15.91"	21.66"		

**80/50 TON TWO STAGE AIR/HYDRAULIC AXLE JACK**

**MODEL 549SD**

- 80 ton stage built for the rigors of the Heavy Duty, Fleet, Agriculture, and Military sectors
- Extra-long 54" handle can be locked in 3 positions for easy placement in confined areas
- Single piece base construction provides superior strength for increased load stability
- Descent metering valve allows for a safe and controlled lowering of the load
- Includes 1.75" and 3" extensions and saddle adapter
- Double polished chrome pistons provide tighter tolerances and greater hydraulic seal
- Safety overload system prevents jack from being used beyond its rated capacity



MODEL	CAPACITY (Tons)	RAM LIFT	LOW HEIGHT	HIGH HEIGHT	HIGH HEIGHT With Extensions	WORKING AIR PRESSURE	SHIP WEIGHT
549SD	80	3.03"	9.06"	13.39"	19.14"	116 to 174 PSI	240 lbs
	50	5.79"	9.06"	17.32"	23.07"		



**1/4 TON-500 LB CLUTCH JACK - HEAVY DUTY**

**MODEL 3700**

- Provides "one-man" operation for removal, installation, and transportation of heavy duty truck clutches
- Includes two splined alignment shafts (2" OD x 1.18" and 1.75" OD x .938 pilot)
- Unique pinned alignment shaft allows technician to remove jack to install clutch assembly without obstruction
- Clutch assemblies can be built on the vertical shaft and then positioned easily under the truck
- Patented clutch head assembly (US patents 5,251,875, and 5,033,717)

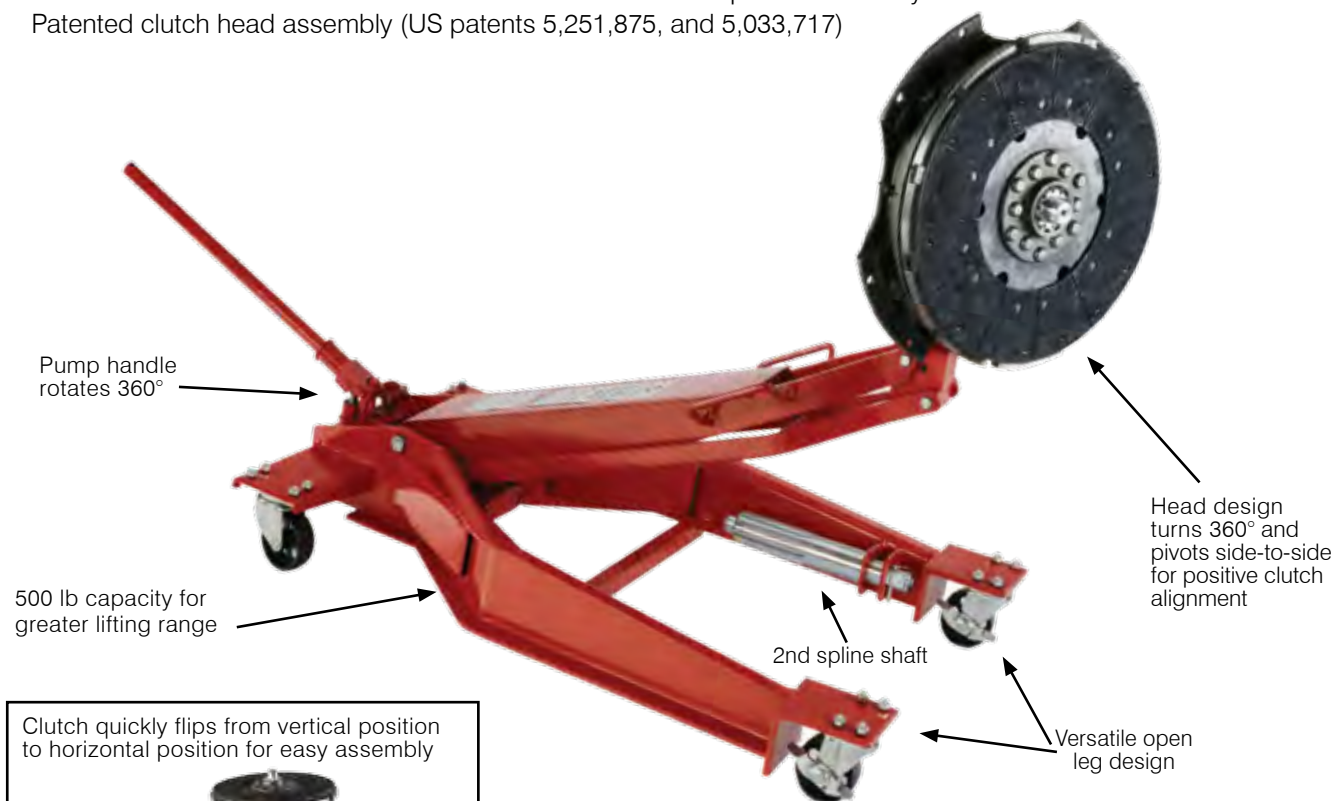

MODEL	CAPACITY (Lbs)	LOW HEIGHT	HIGH HEIGHT	FRAME DIMENSIONS	SHIP WEIGHT
3700	500	13"	39"	36.5" x 22"	139 lbs

**CLUTCH JACK ACCESSORIES**

**FLYWHEEL ADAPTER**

**MODEL 3751**

Easily replaces the spline and bolts onto flat and pot-style truck flywheels used with 14" and 15.5" clutches for more efficient removal and installation.

- Ship weight 6 lbs.



**SPLINED SHAFT**

**MODEL 3749**

- 1.75" OD x 1.18" Pilot
- Ship weight 6 lbs.

**MODEL 3752**

- 1.75" OD x 0.983" Pilot
- Ship weight 6 lbs.

**MODEL 3753**

- 2" OD x 1.18" Pilot
- Ship weight 6 lbs.



**3 TON RATCHETING FARM JACK**

**MODEL 3040A**

- 6,600 lbs lifting capacity
- Versatile ratcheting design is ideal for lifting, pulling, winching, and spreading a tractor or 4-wheel drive vehicle
- Can be used both vertically and horizontally
- Constructed with high-grade steel for extra durability
- Lightweight (32 lbs) and features a 32" long handle with grip



**7 TON FORKLIFT JACK - HEAVY DUTY**

**MODEL 3917**

- Scissors lift from 2.5" to 16.5" for universal coverage of most forklift models
- 14" reach in raised position
- Rugged casters make load alignment easier
- Chassis 26" long x 9" wide
- Safety valve provides critical overload protection



MODEL	CAPACITY (Tons)	LOW HEIGHT	HIGH HEIGHT	REACH	WIDTH	SHIP WEIGHT
3917	7	2.5"	16.5"	14"	9.875"	150 lbs



American Forge & Foundry's Super Duty Bottle Jacks include some of the most advanced features available today and provides countless solutions even in the toughest working conditions. Each is constructed with a welded tank and frame for unsurpassed durability. The air assist models are constructed with a thick base to provide a stable lifting platform even on rough terrain. Check out AFF's Heavy Duty series for a value priced alternative.



### SUPER DUTY AIR ASSIST BOTTLE JACKS

Spring assisted return for added convenience

Specially engineered motor for consistent and effortless air operation

Fully welded tank and frame for superior strength and durability

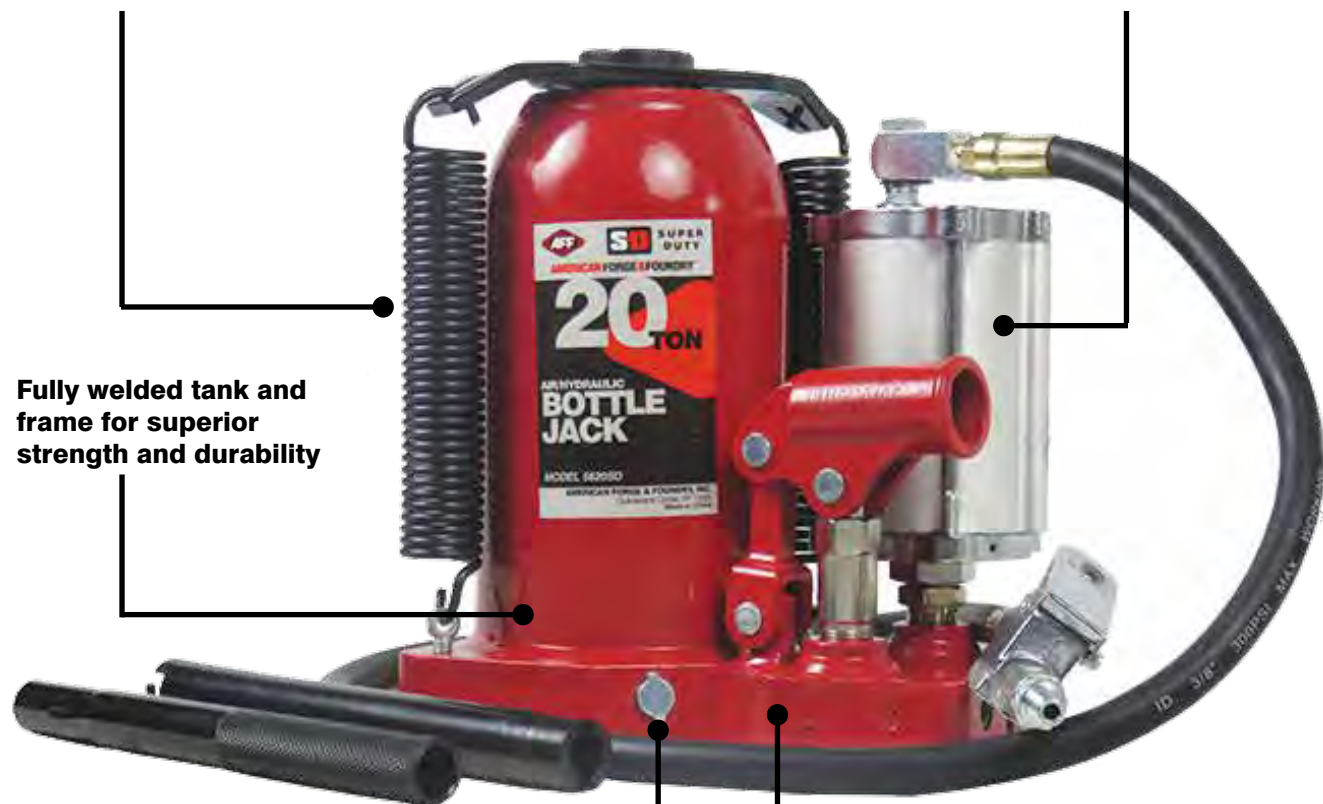

Shielded release screw prevents accidental lowering

Extra thick base provides stable platform even on rough terrain

MODEL	CAPACITY (Tons)	TYPE	LOW HEIGHT	HIGH HEIGHT	BASE	AIR PRESSURE	AIR FITTING	SHIP WEIGHT
5612SD	12	Air Assist	9.92"	18.98"	8.27"x5.31"	110-120 PSI	1/4" NPT	35 lbs
5620SD	20	Air Assist	10.37"	20.63"	8.86"x5.72"	110-120 PSI	1/4" NPT	45 lbs
5621SD	20	Air Assist	7.01"	12.76"	8.27"x5.72"	110-120 PSI	1/4" NPT	36 lbs
5630SD	30	Air Assist	10.94"	20.59"	9.65"x7.09"	110-120 PSI	1/4" NPT	65 lbs

### SUPER DUTY MANUAL HYDRAULIC BOTTLE JACKS

NEW PRODUCT!



Welded cylinder for maximum strength

High grade steel construction



Forged and welded base for extra durability and leak free operation



MODEL	CAPACITY (Tons)	TYPE	LOW HEIGHT	HIGH HEIGHT	BASE	SCREW EXT	SHIP WEIGHT
3602	2	Manual	7.10"	13.60"	4.65"x3.07"	2.50"	6 lbs
3604	4	Manual	7.60"	14.70"	4.92"x3.27"	2.50"	8 lbs
3606	6	Manual	8.30"	16.30"	5.59"x3.62"	2.75"	10 lbs
3608	8	Manual	9.10"	18.10"	6.18"x3.86"	2.75"	13 lbs
3612	12	Manual	9.10"	18.30"	6.81"x4.69"	2.75"	16 lbs
3612S	12	Manual	7.50"	14.40"	6.81"x4.69"	2.00"	23 lbs
3620	20	Manual	9.50"	17.90"	7.60"x5.67"	2.25"	24 lbs
3620S	20	Manual	7.50"	13.80"	7.60"x5.67"	2.25"	17 lbs
3630	30	Manual	10.80"	17.30"	7.95"x5.91"	N/A	31 lbs
3650	50	Manual	10.40"	16.70"	8.58"x6.93"	N/A	57 lbs

Bottle Jacks

Bottle Jacks





## HEAVY DUTY MANUAL BOTTLE JACKS



MODEL	CAPACITY (Tons)	TYPE	LOW HEIGHT	HIGH HEIGHT	BASE	SCREW EXT	SHIP WEIGHT
3502	2	Manual	6.25"	19.75"	3.75"x3.75"	2.50"	6 lbs
3504	4	Manual	6.50"	13.25"	4.50"x4.00"	2.50"	9 lbs
3506	6	Manual	8.00"	16.00"	4.50"x4.75"	2.75"	11 lbs
*3506C	6	Manual	7.75"	16.00"	4.50"x4.75"	2.75"	11 lbs
3508	8	Manual	7.35"	15.50"	4.75"x5.00"	2.75"	13 lbs
3512	12	Manual	8.50"	5.75"	5.50"x5.25"	2.75"	17 lbs
3514	12	Manual	7.00"	13.00"	5.50"x5.25"	2.00"	15 lbs
3520	20	Manual	9.62"	18.25"	6.75"x6.25"	2.25"	27 lbs
3522	20	Manual	7.75"	14.25"	6.75"x6.25"	2.25"	25 lbs
3530	30	Manual	11.00"	18.62"	7.00"x7.00"	N/A	44 lbs
3550	50	Manual	12.00"	19.00"	8.50"x7.00"	N/A	73 lbs
5512B	12	Air Assist	10.25"	19.75"	8.50"x5.00"	3.00"	30 lbs
5520B	20	Air Assist	10.50"	20.00"	9.50"x6.50"	3.25"	38 lbs

\*Includes blow mold carrying case

American Forge & Foundry Air Lifts are designed to quickly and efficiently lift large trucks, tractors, trailers, buses, and heavy construction equipment. All units are 100% air operated and include integrated locking mechanisms to hold the load. Safety stands are recommended to provide additional stability.

### 5-1/2 TON LOW PROFILE/LONG REACH AIR LIFT

#### MODEL 3596

- 48" forward reach provides necessary access to difficult lifting points
- Performs lift at the front axle, frame, or bumper
- 5-1/2 ton capacity performed at 160 PSI
- Steel saddles adjust between 23" and 45" widths to accommodate a variety of vehicle applications
- Includes 2 saddle sizes and drop axle adapter for extra versatility
- Three-way heavy duty air valve for precision lifting
- Automatic safety lock engages in five preset positions

MODEL	CAPACITY (Tons)	LOW HEIGHT	HIGH HEIGHT	LENGTH	BASE WIDTH	OVERALL HEIGHT	SHIP WEIGHT
3596	5.5	6.5"	53.5"	77"	23"	70"	638 lbs

Adapters Included



### 10 TON AIR LIFT JACK

#### MODEL 3400A

- 10 ton capacity achieved at 200-PSI
- Heavy duty air valve offers accurate lift control
- Removable "T" handle allows easy storage
- Extension tubes offer multiple lifting points and locking positions
- 12" lift travel

MODEL	CAPACITY (Tons)	LOW HEIGHT	HIGH HEIGHT	LENGTH	BASE WIDTH	OVERALL HEIGHT	SHIP WEIGHT
3400A	10	18"	52"	27"	12.75"	18.25"	172 lbs



Support Pin



### 10 TON AIR LIFT

#### MODEL 3598

- Constructed with an extra wide stance to lift the entire front or rear of large trucks, buses, and other heavy duty equipment
- 10 Ton capacity achieved at 200 PSI
- 4" x 6" steel saddles adjust between 36" and 50" widths
- Saddle arms reversible for low height loads
- Three-way air valve for high precision lifting and lowering control
- Automatic mechanical lock engages at five lift heights from 17.5" to 50"
- Two air control valve fittings: one for shop air supply and one for a Schrader valve
- Front swivel caster and two pneumatic rear tires for easy positioning
- 13" forward reach (distance from cylinder to saddles)

MODEL	CAPACITY (Tons)	LOW HEIGHT	HIGH HEIGHT	LENGTH	BASE WIDTH	OVERALL HEIGHT	SHIP WEIGHT
3598	10	12.5"	50"	39"	36"	67"	750 lbs





American Forge & Foundry's Safety Stands provide a safe and secure method to hold a load in place while work is being performed under the vehicle. Both ratchet and pin style stands are built with heavy gauge steel and large support saddles. Please note that stands are designed to be used in pairs and the maximum load capacity for a matched pair should not exceed the capacity of an individual stand.

### 10 TON CAPACITY HEAVY DUTY TRUCK STAND

#### MODEL 3310A

- Pin type post adjusts to ten height positions from 28" to 47"
- Extra-large 3.125" x 5.875" support saddle and wide 16"x16" base
- Sold individually
- Ship weight 55 lbs



### 10 TON CAPACITY TRUCK JACK STAND

#### MODEL 3309A

- Pin type post adjusts to seven height positions from 18.5" to 30"
- Extra-large 3.125"x5.875" support saddles and wide 17"x17" base
- Convenient carrying handle for easy portability
- Sold individually
- Ship weight 37 lbs



### 20 TON HEAVY DUTY JACK STAND

#### MODEL 3314

- Pin type post adjusts to four positions from 12" to 20"
- Extra-large 3"x5" saddle
- Stable 10" x 10" base
- Carrying handle for transport
- Sold individually
- Ship weight 50 lbs



Larger handle and ratchet pawl for increased safety

Thicker steel and beefed up design for increased strength

Welded feet for added stability on rough terrain

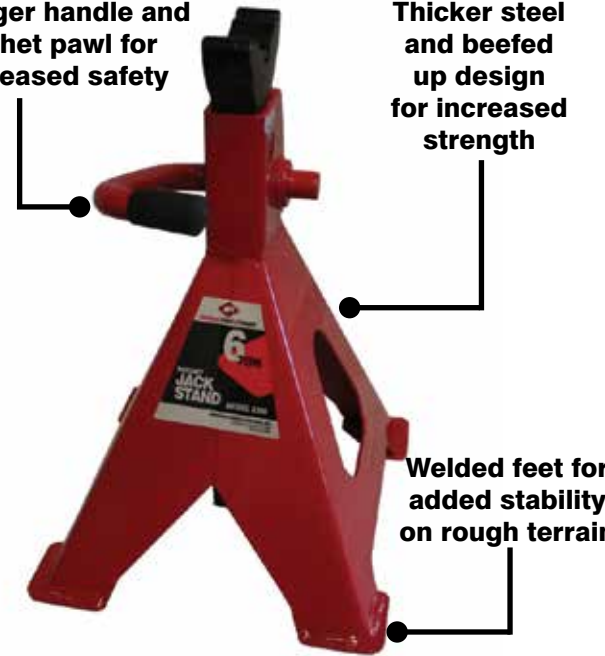

### 6 TON JACK STAND SET

#### MODEL 3306

- Notched saddles for use with unitized body vehicles
- Safety ratchet prevents lowering when saddle is loaded
- Welded feet for added stability even on rough terrain
- Adjusts from 16" to 23.75"
- 9"x10.5" base
- Ship weight 30 lbs per pair



### 12 TON JACK STAND SET

#### MODEL 3312B

- Notched saddles for use with unitized body vehicles
- Safety ratchet prevents lowering when saddle is loaded
- Adjusts from 19.5" to 28"
- 11.625" x 13" base
- Ship weight 67 lbs per pair



### 3 TON JACK STAND SET

#### MODEL 3303

- Notched saddles for use with unitized body vehicles
- Safety ratchet prevents lowering when saddle is loaded
- Welded feet for added stability even on rough terrain
- Adjusts from 11.75" to 17"
- 7"x7.5" base
- Ship weight 16 lbs per pair



### 11 TON PIN STYLE JACK STAND

#### MODEL 3311

- Heavy gauge steel frame prevents distortion and twisting
- Welded steel construction for extra strength and stability
- Built with extra-large saddle
- Pin type post adjusts to three positions from 14" to 20-1/4"
- Carrying handle for quick transport



### 5 TON CAPACITY FORKLIFT JACK STAND SET

#### MODEL 3305A

- Pin type posts adjust to four height positions (13" to 17")
- Extra-large 2.75"x4" support saddles
- Heavy duty 9"x10" base secures load
- Ship weight 29 lbs per pair







**UNDER HOIST COMPONENT STAND  
MODEL 3320A**

- Designed to support vehicle components
- Adjusts from 54.5" to 80.5"
- Includes foot operated pump for extra lift
- Bearing included for smooth operation
- 12" diameter base
- Ship weight 36 lbs

**2 TON HIGH LIFT UNDER HOIST  
STABILIZING STAND**

**MODEL 3315A**

- Designed to support vehicle components only
- Ideal for exhaust and suspension work
- Adjusts from 55" to 85.5"
- Bearing included for smooth operation
- Easily disassembles for storage
- 24"x24"x24" base
- Ship weight 44 lbs



**2 TON UNDER HOIST STABILIZING STAND**

**MODEL 3233A**

- Designed to support vehicle components only
- Adjusts from 66.5" to 73"
- Includes adjusting screw for easier load positioning
- Bearing included for smooth operation
- 21"x21"x21" base
- Ship weight 26 lbs



**50 TON TRAILER STABILIZING STAND  
MODEL 3318**

- 100,000 lb static load capacity
- 45,000 lb lifting capacity
- Can be used to stabilize loaded and unloaded trailers when not connected to trucks
- Adjusts from 39" to 51"
- Pivoting and reversible ratchet head levels trailers on uneven ground
- Wide 14" diameter base for added stability
- Removable pipe handle
- Ship weight 157 lbs



Meets OSHA requirements for stabilizing loaded and unloaded trailer



**7.5 TON FIXED HIGH TRUCK STAND  
MODEL 3342SD**

- Adjustable height range from 57" to 82"
- Twenty one 1" height adjustments with 4" fine adjustment by screw
- Spring loaded casters allow for ease of positioning and portability
- Non-skid rubber saddle pad for secure placement
- Spring loaded tower for easy height adjustment
- Ship weight 134 lbs



**7.5 TON FIXED HIGH TRUCK STAND**

**MODEL 3344SD**

- Adjustable height range from 36" to 54"
- Seventeen 1" height adjustments
- Non-skid rubber saddle for secure placement
- Spring loaded casters for ease of positioning and portability
- Ship weight 103 lb

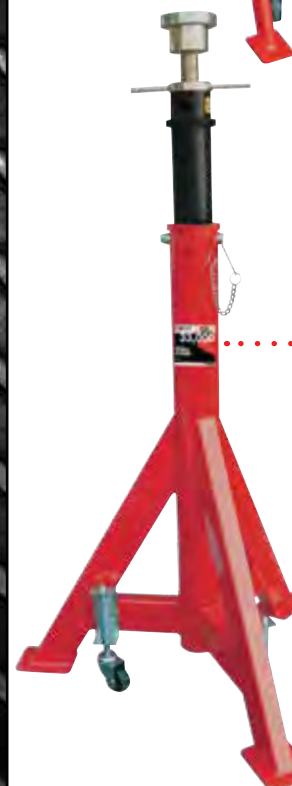

**16.5 TON FIXED HIGH TRUCK STAND  
MODEL 3340SD**

- Adjustable height range from 57" to 82"
- Twenty one 1" height adjustments with 4" fine adjustment by screw
- Spring loaded casters allow for ease of positioning and portability
- Non-skid rubber saddle pad for secure placement
- Spring loaded tower for easy height adjustment
- Ship weight 324 lbs

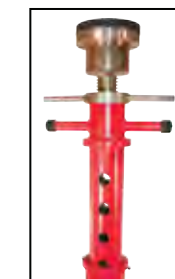

Adjustable Height

**20 TON WIDE STANCE TRUCK RAMPS  
MODEL 3420ASD**

- Long retractable handle
- Wheels ease movement and stores easily out of the way
- Suitable for large truck tires up to 16" maximum width
- Comes with rubber nonskid pad to prevent slippage
- 20 ton capacity per pair
- Frame = 47" L x 18.25" W x 9.25" H
- Overall length = 51"
- Tread Width = 16"
- Ships one pair in wooden crate
- Ship weight 396 lbs. per pair

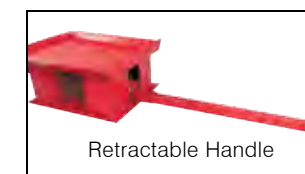

Retractable Handle

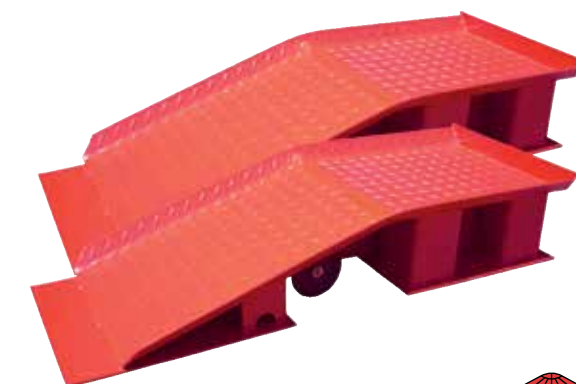



**PORTABLE TRUCK WHEEL DOLLY**  
**MODEL 3590A**

- 300 lb capacity
- Ideal for road service applications
- Rugged tubular steel construction
- Handles wheels up to 24" diameter
- 8" rollers turn and pivot for accurate and efficient alignment of mounted truck tires with hub stubs
- Ship weight 18 lbs.



**SUPER SINGLE TRUCK WHEEL DOLLY**  
**MODEL 3591**

- Easily handles newer design super wide tires
- 26" wide carriage handles tire diameter 36"-48"
- 450 lb capacity
- Heavy duty tubular steel construction
- Bent handle design improves leverage and greatly reduces user strain
- 14" rollers turn and pivot for accurate and efficient alignment of mounted truck tires with hub stubs
- Ship weight 25 lbs.



**3/4 TON HEAVY-DUTY WHEEL DOLLY**  
**MODEL 3577**

- Lift arms adjust inward and outward to handle a variety of different wheel combinations
- Provides extra low access for easy placement of heavy wheel assemblies
- Full 7.75" ram lift
- Six foot safety chain provide added security during transport
- 3 extra-large swivel casters for added mobility
- Fits tires with an outside dimension of 12" to 24"



MODEL	LOW HEIGHT	HIGH HEIGHT	LENGTH	WIDTH	SHIP WEIGHT
3577	2.5"	10.25"	31"	43"	166 lbs

**BRAKE DRUM HANDLER**  
**MODEL 3595A**

- Efficiently installs, removes, and transports 15" to 16.5" brake drums
- Adjustable brackets secure inboard and outboard drums with disc wheel hubs
- Height adjustable rotary handle
- Removable rotating handle
- Ship weight 55 lbs



**AUTOMOTIVE/LIGHT TRUCK WHEEL STEP**  
**MODEL 3911A**

- Wraps over tire to provide a nonslip step
- Adjusts to tire depth and height
- Ideal for loading roof racks, servicing trucks, etc
- Folds flat for easy storage
- 21" L x 7" W
- Capacity 300 lbs
- Ship weight 14 lbs



**HEAVY DUTY TRUCK WHEEL STEP**  
**MODEL 3912A**

- Wraps over tire to provide a nonslip step
- Ideal for loading roof racks, servicing trucks, etc
- Fits truck tires up to 24.5" diameter
- 9" x 27" step with rugged nonslip tread
- Folds flat for easy storage
- Capacity 300 lbs
- Ship weight 17.5 lbs



American Forge & Foundry offers a wide assortment of Hydraulic Rams for use in high force applications including lifting, pulling, pushing, bending, and alignment. Universal design allows use with AFF and other style body and frame repair kits. Styles include mini, snap, screw, pull, wedge, and long configurations.

**4 TON POWER RAM KIT**  
**MODEL 814C**

- Great for bumper damage, body panel, and other automotive repairs
- Blow mold case for easy portability and storage
- Ship weight 43 lbs



**10 TON POWER RAM KIT**  
**MODEL 815C**

- Extra capacity for Heavy Duty equipment work
- Additional wheels on case for easy portability and access
- Ship weight 83 lbs



**814C and 815C include:**

- Model 814-41 4 ton ram or Model 815-41 10 ton ram
- Model 814-11 spreader ram
- Model 814-40 4 ton or Model 815-40 10 ton hydraulic hand pump
- 5", 10", 21", and 24" extension tubes
- 3-1/4" extension tube (814C only)
- Rubber head

- Wedge head
- Spreader ram plunger toes
- Serrated saddle
- Rubber faced flat base
- 90° V-base
- Quick connector
- Model 814K42 72" hydraulic hose

**20 TON POWER RAM KIT**  
**MODEL 818SD**

- Ideal for trucking, farming, and construction
- Comes with 2 metal carry boxes for added mobility and storage
- Ship weight 108 lbs



**Each kit includes:**

- 2-Speed Hydraulic Hand Pump
- 5' Hydraulic Hose
- 20 Ton Ram w/5" stroke
- Extension Tubes (27.5", 20", 10", 5")
- Lock Pin
- Male Connector (3)
- Threaded coupling (3)
- Plunger Base (2)
- Toe Lift
- "V" Head
- Wedge Head
- Serrated Saddle



**20 TON HYDRAULIC RAM FOR 818SD**  
**MODEL 818SD-41**

- Threaded 20-ton ram with 5" stroke
- Direct replacement for ram in the 818SD kit
- Ship weight 30 lbs.

**HYDRAULIC PUMP FOR 818SD KIT**  
**MODEL 818SD-40**

- 2-speed 10,000 psi pump with safety overload protection
- Same unit as pump included in the 818SD kit
- Ship weight 18 lbs.



American Forge & Foundry's Hand and Foot Pumps are designed for portability and ease of use. Constructed with industrial grade material each produces up to 10,000 PSI of high pressure and includes overload protection for added safety.

**4 TON HAND PUMP**

**MODEL 814-40**

- Develops up to 10,000 PSI pressure with overload protection
- 16 cu. in. oil capacity
- Exact replacement for hand pump in AFF Model 814 series 4-ton Body and Frame Repair Kits
- Works with 4KR22 hose
- Ship weight 11 lbs.



**10 TON HAND PUMP**

**MODEL 815-40**

- Develops up to 10,000 PSI pressure with overload protection
- 33 cu. in. oil capacity
- Exact replacement for hand pump in AFF Model 815 series 10-ton Body and Frame Repair Kits
- Works with 4KR22 hose
- Ship weight 15 lbs.



**10 TON CAPACITY AIR/HYDRAULIC FOOT PUMP**

**MODEL 805**

- Converts rams from manual to air/hydraulic operation
- Develops up to 10,000 PSI pressure with overload protection
- Will operate all AFF rams
- Operates at 90 to 120 PSI
- 19.95 oz. oil capacity
- 17-1/2" length
- Ship weight 12 lbs.



**10 TON CAPACITY AIR/HYDRAULIC FOOT PUMP**

**MODEL 806**

- Rugged lightweight aluminum reservoir
- Converts rams from manual to air/hydraulic operation
- Will operate all AFF rams including large diameter & multiple ram configurations
- Operates at 90 PSI and up
- Quick displacement of up to 54.08 oz. hydraulic fluid
- Develops up to 10,000 PSI pressure
- Ship weight 19 lbs.



**PULL KIT WITH HOOKS**

**MODEL 804-09**

- 10-ton Capacity
- 12" to 17" reach
- Ship Weight 11 lbs.



**RAM HALF COUPLER**

**MODEL 4KR20**

- 3/8" high flow coupler for quicker hydraulic system set-up.
- Develops 10,000 PSI capacity
- 1/4" NPT female connection
- For use with all AFF pumps and rams
- Ship weight 1 lb.



**PUMP HOSE HALF COUPLER**

**MODEL 4KR21**

- 3/8" hose
- Develops 10,000 PSI capacity
- 1/4" NPT female connection
- For use with all AFF pumps and rams
- Ship weight 1 lb.



**COMPLETE RAM COUPLER**

**MODEL 4KR22**

- Complete 3/8" quick coupler
- Develops 10,000 PSI capacity
- For use with all AFF pumps and rams
- Ship weight 1 lb.



American Forge & Foundry offers a wide assortment of Hydraulic Rams for use in high force applications including lifting, pulling, pushing, bending, and alignment. Universal design can be used with AFF and other body and frame repair kits. Available styles include: mini, snap style, screw, pull, wedge, and long configurations.



MODEL	CAPACITY (Tons)	TYPE	STROKE	COMPRESSED LENGTH	EXTENDED LENGTH	SPRING RETURN	SHIP WEIGHT
804-11	1/2	Wedge	16.5"	1/2"	4"	NA	5 lbs
812-41	2	Mini	3"	4-3/4"	9-1/2"	No	2 lbs.
LRC3B	3	Long	20-3/4"	24-1/4"	45"	NA	25 lbs
804-10	4	Mini	5/8"	1-1/2"	2-1/4"	No	3 lbs
814-41	4	Snap Style	5"	11"	16"	Yes	4 lbs
LRC8B	8	Long	20-3/4"	24-1/4"	45"	NA	35 lbs
810-07B	10	Mini	2"	4-3/4"	6-3/4"	Yes	6 lbs
810-41	10	Screw	6"	15"	21"	Yes	10 lbs
810-45	10	Long	10"	15-3/4"	25-3/4"	Yes	13 lbs
815-41	10	Snap Style	6"	15"	21"	Yes	12 lbs.

Power Ram

Power Ram





American Forge & Foundry Super Duty Shop Presses are constructed with a fully welded frame and heavier gauge steel for exceptional strength and durability. A lateral head adjuster provides smooth side to side movement of the press head which adds versatility that you won't find with other standard duty shop presses. Optimal use of shop press is 80% of rated capacity or less.

**150 TON SUPER-DUTY SHOP PRESS**  
**MODEL 862ASD**

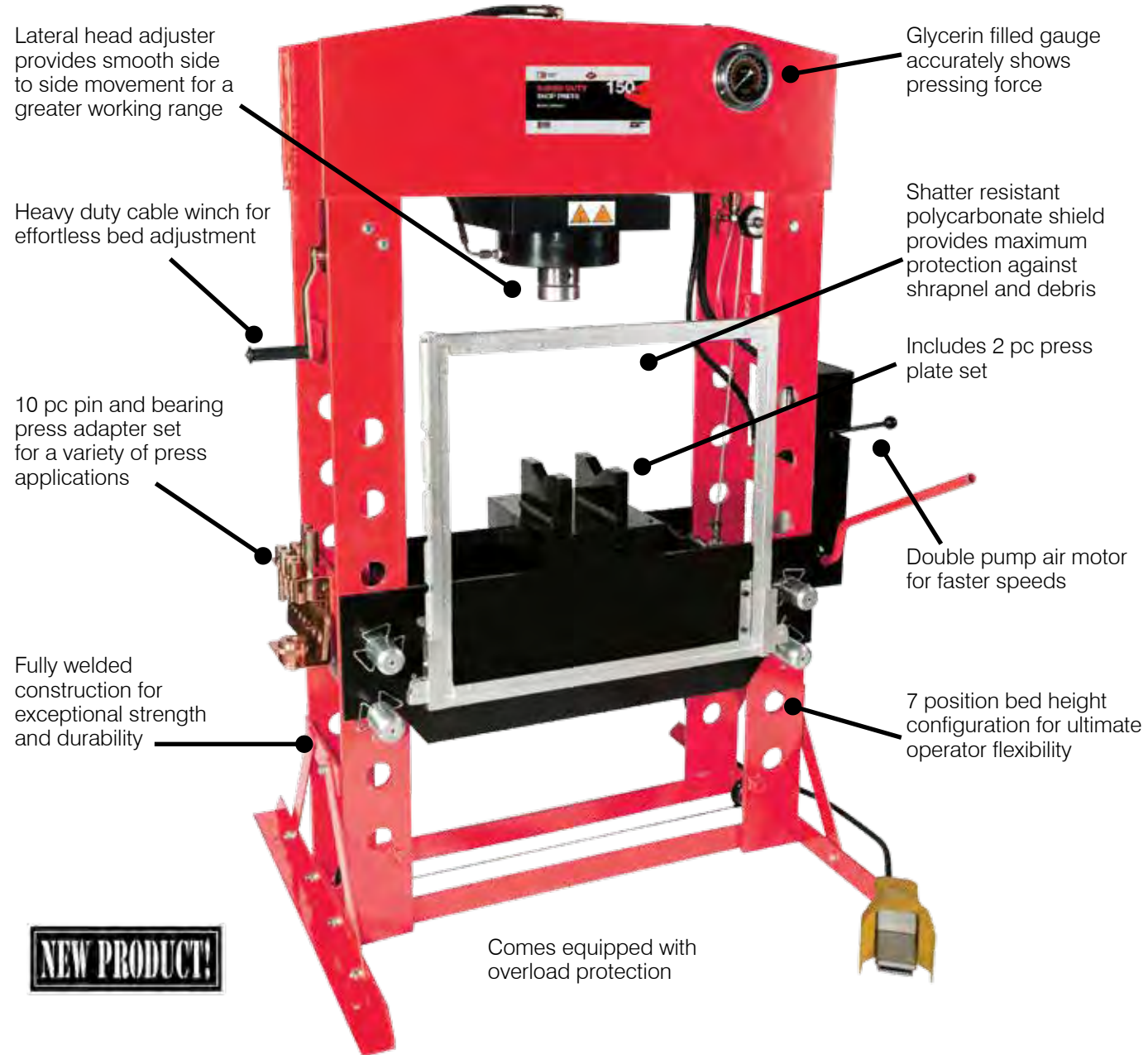

**NEW PRODUCT!**

MODEL	CAPACITY (Tons)	RAM STROKE	OVERALL DIMENSIONS	BED DEPTH	BED WIDTH	THROAT DEPTH	THROAT WIDTH	SHIP WEIGHT
862ASD	150	12.78"	55"Wx85"H	14.17"	39.37"	13.15"	25.24"	2645 lbs
859ASD	100	11.58"	55"Wx84"H	13.50"	31.00"	9.00"	16.50"	1476 lbs
856ASD	75	9.75"	57"Wx77"H	10.87"	31.50"	8.00"	19.75"	1030 lbs.
854ASD	50	7.75"	54"Wx75"H	10.12"	28.75"	7.25"	16.75"	660 lbs.
852ASD	30	5.90"	40"Wx71"H	7.25"	21.50"	6.50"	15.00"	363 lbs.
850ASD	20	7.50"	35"Wx64"H	7.00"	19.25"	5.75"	10.75"	282 lbs.

**MODEL 859ASD**

- Double pump air motor for faster speeds
- Heavy duty cable winch system for effortless bed adjustment
- Shatter resistant polycarbonate guard for added safety
- Large glycerin filled gauge accurately shows pressing force
- Fully welded construction for added durability
- Includes 2 pc press plate set and 10 pc press pin adapter set



**MODEL 856ASD**  
**MODEL 854ASD**

- Heavy duty cable winch system for effortless bed adjustment
- Shatter resistant polycarbonate guard for added safety
- Large glycerin filled gauge accurately shows pressing force
- Fully welded construction for added durability
- Includes 2 pc press plate set and 10 pc press pin adapter set



**MODEL 852ASD**  
**MODEL 850ASD**

- Fully welded construction for added durability
- Shatter resistant polycarbonate guard for added safety
- Large glycerin filled gauge accurately shows pressing force
- Includes 2 pc press plate set and 10 pc press pin adapter set



Shop Presses

Shop Presses





### 50 TON CAPACITY FLOOR PRESS

#### MODEL 837

- Ideal for straightening, bending, and removing gears, bearings, and bushings
- Winch operated press bed with 7 adjustment levels
- Includes 2 pressing plates
- Two-speed hand pump provides faster travel to load while air/hydraulic pump allows for effortless operation
- Frame mounted hydraulic pressure gauge



MODEL	CAPACITY (Tons)	RAM STROKE	SPACE INTERVAL	BED RAIL OPENING	POST OPENING	BASE WIDTH	HEIGHT	SHIP WEIGHT
837	50	7"	5.5"	9"	32"	44"	68"	672 lbs.

### 35 TON CAPACITY FLOOR PRESS

#### MODEL 834

- Ideal for straightening, bending, and removing gears, bearings, and bushings
- Winch operated press bed with 7 adjustment levels
- Includes 2 pressing plates
- Two-speed hand pump provides faster travel to load while air/hydraulic pump allows for effortless operation
- Frame mounted hydraulic pressure gauge



MODEL	CAPACITY (Tons)	RAM STROKE	SPACE INTERVAL	BED RAIL OPENING	POST OPENING	BASE WIDTH	HEIGHT	SHIP WEIGHT
834	35	6.5"	4.5"	7.5"	24"	30"	66"	312 lbs.

### 30 TON CAPACITY FLOOR PRESS

#### MODEL 832A

- Ideal for straightening, bending, and removing gears, bearings, and bushings
- 8 level bed adjustment
- 30 ton bottle jack with overload protection (6-1/2" stroke)
- Heavy duty return springs for fast ram retraction
- Reinforced head plate



MODEL	CAPACITY (Tons)	RAM STROKE	SPACE INTERVAL	BED RAIL OPENING	POST OPENING	BASE WIDTH	HEIGHT	SHIP WEIGHT
832A	30	6.5"	4.5"	7.25"	22.5"	30"	66"	405 lbs.

### 20 TON CAPACITY FLOOR PRESS

#### MODEL 820A

- Ideal for straightening, bending, and removing gears, bearings, and bushings
- 8 level bed adjustment
- 20 ton bottle jack with overload protection (8-1/2" stroke)
- Heavy duty return springs for fast ram retraction
- Reinforced head plate



MODEL	CAPACITY (Tons)	RAM STROKE	SPACE INTERVAL	BED RAIL OPENING	POST OPENING	BASE WIDTH	HEIGHT	SHIP WEIGHT
820A	20	8.5"	4.5"	7.25"	22.5"	27"	61"	280 lbs.

### REPLACEMENT ARBOR PLATES

#### MODEL 820AK7

Pair of arbor plates fits Model 820A 20-ton Floor Press  
Ship weight 51 lbs.



#### MODEL 832AK12

Pair of arbor plates fits Model 832A 30-ton Floor Press  
Ship weight 99 lbs.



### REPLACEMENT POLYCARBONATE SHOP PRESS GUARDS

- Shatter resistant polycarbonate material provides maximum protection against shrapnel and other debris
- No additional hardware needed if you have an existing AFF brand Super Duty Shop Press
- Fits the following AFF Shop Presses: 850SD, 850ASD, 852SD, 852ASD, 854SD, 854ASD, 856SD, 856ASD, 859SD, and 859ASD

#### MODEL 850ASD-P

- Polycarbonate guard for Models 850SD and 850ASD 20 Ton Shop Press

#### MODEL 856ASD-P

- Polycarbonate guard for Models 856SD and 856ASD 75 Ton Shop Press

#### MODEL 852ASD-P

- Polycarbonate guard for Models 852SD and 852ASD 30 Ton Shop Press

#### MODEL 859ASD-P

- Polycarbonate guard for Models 859SD and 859ASD 100 Ton Shop Press

#### MODEL 854ASD-P

- Polycarbonate guard for Models 854SD and 854ASD 50 Ton Shop Press





### HEAVY DUTY WORKBENCH

#### MODEL 990

- 10-gauge rolled edge steel work top with 2" retaining wall on sides and back (1750 lb. load capacity)
- Two 12-gauge steel shelves each with a 550 lb. load capacity



10 Gauge Steel Powder Coated Finish

MODEL	WORKTOP CAPACITY	DRAWERS	SHELF CAPACITY	NUMBER SHELVES	LENGTH	WIDTH	HEIGHT	SHIP WEIGHT
990	1750 lbs.	N/A	550 lbs.	2	79"	25.25"	34.5"	275 lbs.

### HEAVY DUTY WORKBENCH

#### MODEL 992

- 10-gauge rolled edge steel work top with 2" retaining wall on sides and back (1750 lb. load capacity)
- Two key lock steel drawers with full extension ball bearing slides
- One 12-gauge steel shelf with a 550 lb. load capacity



10 Gauge Steel Powder Coated Finish

MODEL	WORKTOP CAPACITY	DRAWERS	SHELF CAPACITY	NUMBER SHELVES	LENGTH	WIDTH	HEIGHT	SHIP WEIGHT
992	1750 lbs.	2	550 lbs.	1	59"	25.25"	34.5"	236 lbs.

### 1/2 TON-1100 LB HEAVY DUTY HYDRAULIC TABLE CART

#### MODEL 3904

- 1100 lb total capacity
- Positions and raises work piece from 11" to 36"
- Extra-large 32" x 19.5" work area
- Foot operated pedal keeps your hands free
- Constructed with two wheel brakes for added safety
- Handle mounted pressure release
- Ship weight 195 lbs



Tapered table top with drain hole allows convenient fluid drainage into plastic container.

### HEAVY DUTY TEARDOWN TABLE

#### MODEL 994

- Fluids drain through table top into a removable plastic container
- Comes with locking storage drawer on ball bearing slides
- Multiple shelf location adds versatility
- Square tube leg design adds strength and stability to table top
- Large 4" heavy duty swivel casters (2 locking)
- Table top features 1/2" rim
- Extra heavy duty construction



10 Gauge Steel Powder Coated Finish

MODEL	WORKTOP CAPACITY	DRAWERS	SHELF CAPACITY	NUMBER SHELVES	LENGTH	WIDTH	HEIGHT	SHIP WEIGHT
994	1000 lbs.	1	1500 lbs.	1	48"	31"	40"	249 lbs.

### 5" GENERAL DUTY SWIVEL VISE

#### MODEL 3941

- Class 30 iron
- 30,000 lb. tensile strength castings
- Precision machined hardened steel jaws (replaceable)
- Built-in pipe jaws
- Machine ground anvil surface
- 360° swivel base with dual lock down handles
- Maximum opening : 5"
- Throat depth: 3"
- Ship weight: 29.7 lbs.



### 6" GENERAL DUTY SWIVEL VISE

#### MODEL 3942

- Class 30 iron
- 30,000 lb. tensile strength castings
- Precision machined hardened steel jaws (replaceable)
- Built-in pipe jaws
- Machine ground anvil surface
- 360° swivel base with dual lock down handles
- Maximum opening : 6"
- Throat depth: 3-1.2"
- Ship weight: 44 lbs.



### 8" GENERAL DUTY SWIVEL VISE

#### MODEL 3943

- Class 30 iron
- 30,000 lb. tensile strength castings
- Precision machined hardened steel jaws (replaceable)
- Built-in pipe jaws
- Machine ground anvil surface
- 360° swivel base with dual lock down handles
- Maximum opening : 8"
- Throat depth: 4"
- Ship weight: 68.2 lbs.



### 5" MULTI-PURPOSE SWIVEL VISE

#### MODEL 3944

- Class 30 iron
- 30,000 lb. tensile strength castings
- Precision machined hardened steel jaws (replaceable)
- Built-in pipe jaws
- Machine ground anvil surface
- 360° swivel base with dual lock down handles
- Maximum opening : 5"
- Throat depth: 2-5/8"
- Ship weight: 35.2 lbs.



### 5" HEAVY DUTY SWIVEL VISE

#### MODEL 3947

- Extra heavy duty casting provides high clamping force
- Fully enclosed spindle, slide, and screw prevents grit, grime, and other contaminants from entering chamber
- Permanently sealed and lubricated chamber allows years of smooth operation
- Precision machined hardened steel jaws (replaceable)
- 360° swivel base with double lock down handles
- Large anvil work surface
- Maximum opening: 5-1/4"
- Throat depth: 3-3/4"
- Ship weight: 53 lbs



### 6" HEAVY DUTY SWIVEL VISE

#### MODEL 3948

- Extra heavy duty casting provides high clamping force
- Fully enclosed spindle, slide, and screw prevents grit, grime, and other contaminants from entering chamber
- Permanently sealed and lubricated chamber allows years of smooth operation
- Precision machined hardened steel jaws (replaceable)
- 360° swivel base with double lock down handles
- Large anvil work surface
- Maximum opening: 6"
- Throat depth: 4"
- Ship weight: 66 lbs

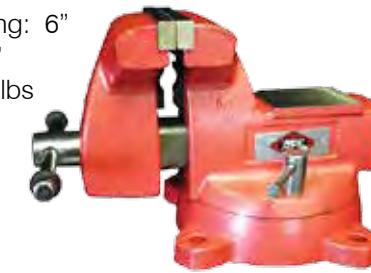



**6" BENCH GRINDER**

**MODEL 31510**

- Adjustable steel work rest
- 1 Standard Safety Glass, 1 Magnifying Safety Glass
- Cast aluminum base
- Large flexible work light (bulb not included)
- Water Tray
- Dust proof switch
- 6" Grinder
- 1/2 HP Ball bearing motor 120V, 2.8 Amp 60 Hz
- 1/2" Arbor
- 3/4" Wheel Width
- 3,450 RPM (no load speed)
- Ship weight 21 lbs.



**8" BENCH GRINDER**

**MODEL 31520**

- Adjustable steel work rest
- 1 Standard Safety Glass, 1 Magnifying Safety Glass
- Cast aluminum base
- Large flexible work light (bulb not included)
- Water Tray
- Dust proof switch
- 8" Grinder
- 3/4 HP Ball bearing motor 120V, 4.8 Amp 60 Hz
- 5/8" Arbor
- 1" Wheel Width
- 3,450 RPM (no load speed)
- Ship weight 33 lbs.



**ADJUSTABLE HEIGHT STAND**

**MODEL 31500**

- Extra large 12" x 10" steel table top reduces vibration and breakage compared to typical cast tops.
- Predrilled slots allow for mounting most bench grinders 5"-10".
- Heavy duty cast iron base predrilled for securing
- Adjustable table height from 28" - 36"
- Ship weight 20 lbs.



**FIXED HEIGHT STAND**

**MODEL 31501**

- SAME AS MODEL 31500
- Height 32"
- Ship wt 23 lbs.



**AIR PISTON CREEPER SEAT**

**MODEL 3907**

- Padded and reinforced seat
- Air piston allows height adjustment to 18"
- Under seat parts tray keeps tools at hand
- Five 2-1/2" heavy duty casters
- Ship weight 14 lbs



**CREEPER SEAT**

**MODEL 3906**

- Padded, reinforced, oil-resistant vinyl seat (1-3/4" thick)
- Convenient under seat tray keeps tools and small parts
- 1" steel tube frame with four 2-1/2" ball bearing casters
- Fully assembled
- 17-1/2" L x 14" W x 14" H
- Ship weight 10 lbs.



**SUPER DUTY CREEPER XL**

**MODEL 3909**

- 47" total length and 440 total lbs capacity
- Constructed with high density polyethylene to prevent warpage in any climate
- Urethane wheels provide added corrosion resistance
- Build with magnetic trays to keep tools and parts within reach
- "Breathing holes" for added ventilation and comfort
- Easy to clean surface is resistant to solvents and grease
- Total dimensions: 47.00"L x 23.60"W



Magnetic tray keeps bits and parts in its place



**GARAGE CREEPER**

**MODEL 3910**

- Padded head rest and shoulder relief for additional working comfort
- Convenient storage trays for tools and parts
- Swivel rollers glide easily on most shop floors
- Easy to clean surface is resistant to solvents and grease
- Total dimensions: 39.50" x 18.50"



**37" CREEPER**

**MODEL 3905**

- Full length, padded, oil-resistant vinyl center panel (1-3/4" thick)
- Additional 1-1/2" thick headrest
- Six 2-1/2" swivel casters
- 37" L x 18" W x only 3-1/2" H
- Ship weight 16 lbs.



Double post caster mounting bolts are stronger, longer lasting and more durable

**42" HEAVY DUTY MECHANICS CREEPER**

**MODEL 3908**

- Longer and wider for additional working comfort
- Drop frame at shoulder for ease of movement
- Full length, padded, oil-resistant vinyl center panel
- Six heavy duty, dual-post casters
- 42" L x 21" W x 3-1/2" H
- Ship weight 21 lbs.



Double post caster mounting bolts are stronger, longer lasting and more durable



American Forge & Foundry parts washers are designed for fast and efficient cleaning of vehicle parts and sub-assemblies. Each unit includes a fusible linked fire cover for maximum operator safety. Each is designed for use with aqueous water-based cleaners.

### 7 GALLON PORTABLE PARTS WASHER

#### MODEL 31350B

- 3-1/2 gallon working capacity
- 45 GPH pump output
- UL listed on complete unit
- 18-1/2" x 13-1/2" x 9" overall dimensions
- Ship weight 18 lbs.



### 20 GALLON HYDRA-FLOW PARTS WASHER

#### MODEL 31200B

- 12-gallon working capacity
- 50 GPH pump output
- Removable work shelf and parts basket
- UL listed on complete unit
- 30" x 20-1/2" x 36-1/2" overall dimensions
- Ship weight 62 lbs.



### 40 GALLON INDUSTRIAL-DUTY PARTS WASHER

#### MODEL 31400B

- 22 gallon working capacity
- 50 GPH pump output
- Removable work shelf and parts basket
- UL Listed on complete unit
- 45" x 21-1/4" x 35-5/8" overall dimensions
- Ship weight 107 lbs.



### FLO-THRU PARTS WASHER BRUSH

#### MODEL PWBRUSH

- Reduces parts cleaning time by 50%
- 4" long bristles suitable for use with water-based (aqueous) cleaner, as well as petroleum-based product
- Easy attachment fitting
- Fits all AFF parts washers
- 10" L x 1-1/2" W
- Ship weight 2 lbs



### 2 SHELF POLYPROPYLENE SHOP CART

#### MODEL 961

- 5" x 1" casters (2 swivel, 2 fixed)
- Convenient organizer tray
- Super strong polypropylene
- 500 lb. overall capacity.
- Tray size: 30"L x 16"W x 3" D
- 39.75"L x 17"W x 33.25"H overall
- Ship weight 40 lbs..



### ADD-A-SHELF

#### MODEL 964

- 36" x 24"
- Ship weight 16 lbs.

### 2 SHELF POLYPROPYLENE SHOP CART

#### MODEL 962

- SAME AS ABOVE except:
- Tray size: 36"L x 24"W x 3" D
- 46"L x 25.5"W x 33.25"H overall
- Ship weight 51 lbs.

### ADD-A-SHELF

#### MODEL 963

- 30" x 16"
- Ship weight 13 lbs.

### POWER MAT XL

#### MODEL 3902

- Thick closed cell EVA foam material protects workers from hard and rough surfaces
- Can be used as an anti-fatigue mat, kneeling pad, under car mat, or anywhere a worker needs to be kept off the ground
- Resists absorption of water, oil, and many chemicals
- Ultra-lightweight for easy portability with convenient hand hole for carrying
- Product dimensions: 43"x19-5/8"x1-3/16"
- Ship weight 23 lbs.

### POWER MAT

#### MODEL 3901

- Same as 3902 except:
- Product dimensions: 19-1/4"x11-3/4"x1-3/16"
- Ship weight 16.5 lbs.



### 3/8" AIR HOSE REEL

#### MODEL 760

- Mounting base is slotted and roller arm has 5 positions for multiple mounting configurations.
- Heavy steel construction adds durability and longer life cycles
- Rubber air hose with heavy-duty crimping and spring guard ensure longevity
- Automatic return via heavy-duty sealed spring with 8 locking stops, roller guide and ball stop
- 3/8" x 50'
- 1/4" NPT
- 300 PSI maximum pressure
- Ship weight 40 lbs.

### 1/2" AIR HOSE REEL

#### MODEL 761

- Same as 760 except:
- 1/2" x 50'
- 1/2" NPT
- 300 PSI maximum pressure
- Ship weight 53 lbs.





American Forge & Foundry's Engine Cranes are designed for easy and efficient removal and transport of vehicle engines. Each feature four position telescopic booms, wide stable bases, forged steel hooks with safety latches, and heavy duty swivel casters. Stands are available to help position the engine for optimal work.

**2 TON-4400 LB CAPACITY FOLDABLE ENGINE CRANE**

**MODEL 3582**

- Folds up for easy storage (57"H x 12" W x 27" D)
- Boom extends from 40" to 63"
- 69" base length
- Ship weight 225



MODEL	CAPACITY (Lbs)	Boom (Lbs) Capacity				Maximum Horizontal Reach				Maximum Hook Height				SHIP WEIGHT
		1	2	3	4	1	2	3	4	1	2	3	4	
3582	4400	4400	3300	2200	1100	23"	31"	38"	45"	72.5"	77.5"	82"	87"	225 lbs

**3 TON-6000 LB CAPACITY HEAVY-DUTY ENGINE CRANE**

**MODEL 3584**

- Reinforced leg assemblies for added strength and durability
- 4 different boom settings: 3, 2, 1.5, and 1 Ton
- Rear of crane is 61.5" tall and 33" wide
- Distance between front of legs: retracted 23" / extended 28.5"
- Large 4.25" rear swivel casters and 6" fixed front wheels provide ease of mobility and positioning
- Constructed with built in safety overload to protect the unit from being used being its rated capacity
- Ship weight 355 lbs.



**WORKING DIMENSIONS**

Ton Setting	Max Ht.	Max Reach
3 Ton 6,000 lbs	87.0"	35"
2 Ton 4,000 lbs	91.5"	42"
1.5 Ton 3,000 lb	95.5"	50"
1 Ton 2,000 lbs	99.5"	61"

**1/2 TON-1000 LB TRUCK MOUNTED CRANE**

**MODEL 3586B**

- Rugged steel construction
- Boom working range: 28" to 42.5"
- Locking swivel base - 360 degree swivel
- Heavy duty chain with safety lock
- Hydraulic operation provides easy lifting to desired height
- Designed to be installed in truck beds or vans
- Includes mounting plate and chain with grab hook
- Lifting range 0-75"
- Ship weight 106 lbs.



Shown in DOWN position



**700 LB. CAPACITY TRANSVERSE ENGINE SUPPORT WITH ADDED SUPPORT BAR**

**MODEL 584**

- Three support points for added stability
- 700 lb. capacity
- 2 - 14" adjustable hook screws
- 2.125" x 38" braided steel cables
- Width expands from 34.5" to 61"
- Ship weight 27 lbs.



**1/2 TON-1100LB CAPACITY ENGINE SUPPORT**

**MODEL 583**

- Provides overhead engine support for removal of transaxle on FWD vehicles
- Ideal for four and six cylinder FWD vehicles
- Adjusts from 26.5" to 49.5" wide with 18.75" screw travel
- Ship weight 38 lbs.



**1 TON-2200 LB CAPACITY ENGINE TILTER**

**MODEL 582**

- For use with AFF cranes to effectively change engine's center of gravity during installation or removal
- 23.5" wide support bracket
- Ship weight 19 lbs





**1/2 TON-1000 LB. CAPACITY ENGINE STAND**

**MODEL 571B**

- Wide 4 point "H" type base ensures good stability
- Adjustable brackets allow maximum flexibility – fits most small engines
- 360° rotating head enables engine to be placed in desired work position
- Full swivel casters
- Heavy duty welded steel base



MODEL	CAPACITY (Lbs)	LENGTH	FRONT WIDTH	REAR WIDTH	SHIP WEIGHT
571B	1000	36"	19.5"	33.25"	67 lbs

**1250 LB. CAPACITY ENGINE STAND**

**MODEL 573B**

- Extra wide 4-point "U" type base ensures maximum stability and performance
- Adjustable brackets allow maximum flexibility – fits most automobile and light truck engines
- 360° rotating head enables placement of engine in desired work position
- Full swivel casters
- Heavy duty welded steel base
- Includes convenient tray for storing tools and parts



MODEL	CAPACITY (Lbs)	LENGTH	FRONT WIDTH	REAR WIDTH	SHIP WEIGHT
537B	1250	34"	33"	33"	83 lbs

American Forge & Foundry's Material Handling include a wide selection of portable equipment to allow you to quickly and easily move a variety of drums and other shop supplies. Chain, Lever, and Cable hoists provide effortless lifting and lowering of heavy materials.

**13.2 GALLON DRUM BAND DOLLY**

**MODEL 8625**

- Designed to efficiently move 13.2-gallon drums and pails
- Adjustable band clamp holds load securely
- Four rubberized casters for directional stability
- 13.75" inside diameter for complete coverage
- Ship weight 8 lbs.



**55 GALLON DRUM BAND DOLLY**

**MODEL 8655**

- 660 lb capacity
- Moves 55 gallon steel, plastic, and fiber drums safely and easily
- Heavy duty all steel construction
- Constructed with four 3" swivel casters for easy transport
- 24.375" band diameter
- Ship weight 24 lbs



**55 GALLON DRUM CRADLE**

**MODEL 8656**

- 660 lb capacity
- Tip, drain, and store 55 gallon drums with ease (drum not included)
- Cradle supports drum 17" off floor
- Constructed with four wheels for easy positioning
- 34" L x 21" W x 17" H
- Ship weight 24 lbs





**2 TON PALLET JACK**

**MODEL 3900A**

- High tensile steel frame with 5,500 lb total capacity
- Quickly lifts from 3" to 7.75"
- Extra-large 27" x 48" platform
- Full 180° steering arc
- Durable polyurethane coated steel wheels and entry rollers
- Three position control lever automatically returns to neutral position
- Durable sealed pump with overload safety system
- Ship weight 228 lbs.

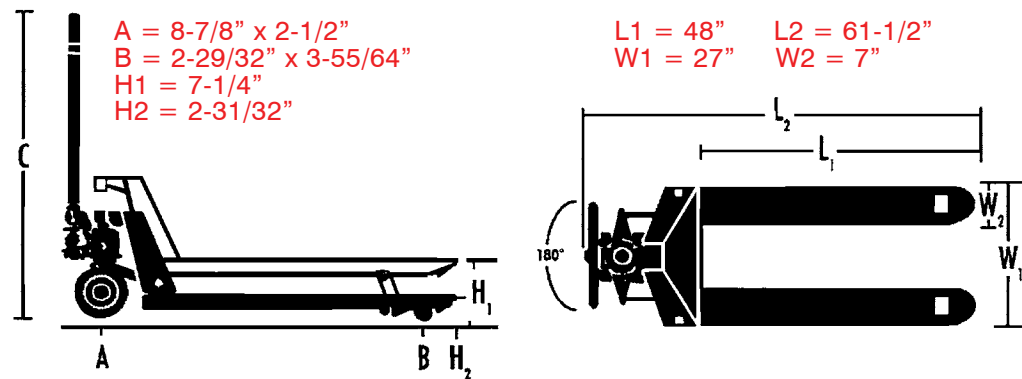

**POLYPROPYLENE DRUM DOLLY**

**MODEL 8654**

- Designed for 30 and 50 gallon capacity drums
- 2 steps – 18.75" diameter and 23.25" diameter
- Constructed with 5 heavy duty casters with threaded inserts to prevent "tear out."
- 660 lb total capacity
- Ship weight 22 lbs



**CHAIN HOISTS**

- Factory tested to 150% of rated capacity
- Rugged triple spur gear
- Safety brake to prevent slippage
- Hardened steel alloy chain for safe, smooth operation
- Forged safety hooks included

**MODEL 4001**  
1 TON  
2,000 LB. CAPACITY  
CHAIN HOIST



**MODEL 4002**  
2 TON  
4,000 LB. CAPACITY  
CHAIN HOIST



**MODEL 4003**  
3 TON  
6,000 LB. CAPACITY  
CHAIN HOIST



**MODEL 4005**  
5 TON  
10,000 LB. CAPACITY  
CHAIN HOIST



MODEL	CAPACITY (lbs.)	LIFT (ft)	CHAIN DIAMETER	# of FALLS	# OF SAFETY HOOKS	SHIP WEIGHT
4001	2,000	8	1/4"	1	2	23 lbs.
4002	4,000	10	1/4"	1	2	30 lbs.
4003	6,000	10	3/8"	2	2	50 lbs.
4005	10,000	10	5/16"	2	2	91 lbs.

**1-1/2 TON**  
**3,000 LB. LEVER HOIST**  
**MODEL 4008**

- Durable steel frame
- Lightweight and easy to use
- Guide slots to guard against jamming or slippage
- 1/4" link chain
- Includes two safety hooks
- Lift is 5 ft.
- 1 Fall
- Ship weight 25 lbs.



**CABLE PULLER**  
**MODEL 30400**

- 8,000 lb. capacity
- 3/16" cable diameter
- 5.5' cable length
- Ship weight 14 lbs.



**CABLE PULLER**  
**MODEL 30200**

- 4,000 lb. capacity
- 3/16" cable diameter
- 5' cable length
- Ship weight 7 lbs.

- Ideal for lifting, lowering, pulling, and stretching applications
- Hardened steel pivot points for extra strength
- Forged safety hooks included



American Forge & Foundry has a growing line of hand tools, torque tools, and accessories to serve the Automotive, Industrial, and MRO markets. Each tool is carefully designed and manufactured using superior materials and workmanship in order to ensure the highest productivity and performance standards.

### Invincible Handle Hammers

- Spring steel rods encased in vulcanized rubber provide the ultimate striking tool handle
- Drop forged heads are induction hardened for superior durability
- Patented steel locking plate makes head separation impossible
- Handle absorbs impact and vibration reducing user fatigue
- Hi-visibility head provides instant identification on any job site
- Steel reinforced lanyard hole reduces change of slippage
- Copper head series resists sparking and minimizes damage to the work area



MODEL	TYPE	HEAD WEIGHT (lbs)	PRODUCT WEIGHT (lbs)	HANDLE LENGTH (inches)	SHIP WEIGHT (lbs)
50100	Club	2.50	3.85	12	4.00
50105	Club	4.00	5.25	12	5.25
50110	Club	4.00	5.75	16	5.75
50206	Sledge	6.00	8.70	16	9.00
50208	Sledge	8.00	10.00	16	10.20
50210	Sledge	8.00	11.10	24	11.50
50220	Sledge	8.00	12.00	30	12.20
50222	Sledge	8.00	13.00	36	13.20
50224	Sledge	12.00	17.50	36	18.00
50230	Sledge	14.00	18.50	30	18.20
50300	Ball Pein	2.50	2.90	16	2.90
50400	Cross Pein	3.50	5.10	16	5.10
50107	Copper Club	4.00	5.75	12	5.75
50217	Copper Sledge	8.00	11.50	24	11.50
50237	Copper Sledge	14.00	18.20	30	18.20

### Heavy Duty Dead Blow Hammers

- Steel shot filled canister creates a "dead blow effect" to absorb the shock of impact.
- Hammer sustains impact, maximizes force, and eliminates rebound
- One-piece urethane construction will not spark, absorb liquid, or damage the work area
- Steel reinforced handle provides added strength and safety by eliminating breakage
- Reduces noise when striking metal objects such as slugging/striking wrenches
- Red color provides high visibility
- Ball Pein style ideal for punches and chisels as well as shaping and straightening unhardened metals



MODEL	TYPE	HEAD WEIGHT (lbs)	PRODUCT WEIGHT (lbs)	HANDLE LENGTH (inches)	SHIP WEIGHT (lbs)
50500	Standard Head	1.00	1.08	11.00	1.08
50501	Standard Head	1.50	1.64	12.00	1.64
50502	Standard Head	2.25	2.39	13.50	2.39
50503	Standard Head	3.00	3.20	16.75	3.20
50504	Standard Head	6.00	6.47	20.00	6.47
50505	Sledge Head	10.00	11.13	30.00	11.13
50506	Sledge Head	12.00	12.68	36.50	12.68
50601	Ball Pein	1.50	2.39	13.00	2.39



**1/2" DRIVE 5 PC TORQUE LIMITING EXTENSION SET**

**MODEL 40012**

- Prevents overtightening or uneven tightening of lug nuts
- Spring steel design stops turning once preset torque is reached
- Reduces risk of wheel and brake rotor damage
- Laser etched with size and torque rating for easy identification
- Includes carrying case for easy storage and organization
- Ship weight 3.25 lbs



**INCLUDES:**

MODEL	COLOR	FT/LB
40065	Yellow	65
40080	Blue	80
40100	Gray	100
40120	White	120
40140	Lt. Blue	140

**1/2" DRIVE 10 PC METRIC/SAE MASTER TORQUE LIMITING SOCKET SET**

**MODEL 40200**

- Prevents overtightening or uneven tightening of lug nuts
- Spring steel design stops turning once preset torque is reached
- Reduce risk of wheel and brake rotor damage
- Solid one piece construction
- Laser etched with size and torque rating for easy identification
- Includes carrying case for easy storage and organization
- Ship weight: 32 lbs



**INCLUDES:**

MODEL	COLOR	SIZE	FT/LB
40205	Green	17mm	55
40210	Red	17mm	80
40215	Yellow	19mm-3/4"	65
40220	Blue	19mm-3/4"	80
40225	Lt. Brown	21mm	80
40230	Brown	13/16"	100
40235	Gray	19mm-3/4"	100
40240	White	22mm-7/8"	120
40245	Turquoise	22mm-7/8"	140
40250	Lt. Green	24mm-15/16"	140

**3/4" DRIVE 4 PC TORQUE LIMITING SOCKET SET**

**MODEL 40300**

- Prevents overtightening or uneven tightening of lug nuts
- Spring steel design stops turning once preset torque is reached
- Reduce risk of wheel and brake rotor damage
- Solid one piece construction
- Laser etched with size and torque rating for easy identification
- Includes carrying case for easy storage and organization
- Ship weight: 16.17 lbs



**INCLUDES:**

MODEL	COLOR	SIZE	FT/LB
40301	Red	1-1/4"	250
40302	Brown	33mm-1-5/16"	475
40303	Black	1-1/2"	475
40304	Yellow	13/16"	475

**1" DRIVE 4 PC TORQUE LIMITING SOCKET SET**

**MODEL 40400**

- Prevents overtightening or uneven tightening of lug nuts
- Spring steel design stops turning once preset torque is reached
- Reduce risk of wheel and brake rotor damage
- Solid one piece construction
- Laser etched with size and torque rating for easy identification
- Includes carrying case for easy storage and organization
- Ship weight: 18.37 lbs



**INCLUDES:**

MODEL	COLOR	SIZE	FT/LB
40401	Red	1-1/4"	250
40402	Brown	33mm-1-5/16"	475
40403	Black	1-1/2"	475
40404	Yellow	13/16"	475



**1" DRIVE 33MM 550 FT/LB TORQUE LIMITING SOCKET**

**MODEL 40405**

- Prevents overtightening or uneven tightening of lug nuts
- Spring steel design stops turning once preset torque is reached
- Reduce risk of wheel and brake rotor damage
- Solid one piece construction
- Laser etched with size and torque rating for easy identification
- Ship weight 4.50 lbs.



MODEL	COLOR	SIZE	FT/LB
40405	Gray	33mm	550

**Ratcheting Torque Wrenches**

- Accurate in clockwise direction +/- 4% from 20% to 100% of full scale and includes certificate of calibration
- Conforms to the accuracy requirements of the American Standards Institute ASME B107.14-1194, BSEN 26789:1994, ISO 6789-1992, DIN 3122, and U.S. Government Specification GGG-W-00686C
- Perceptible jolt and audible click indicate desired torque setting has been reached
- Locking collar prevents accidental setting adjustment
- Pliable handle grip for superior comfort and oil resistance
- Rubber seal between the ratchet head and tube keeps lubrication in and contaminants out
- Includes protective blow mold case for easy storage

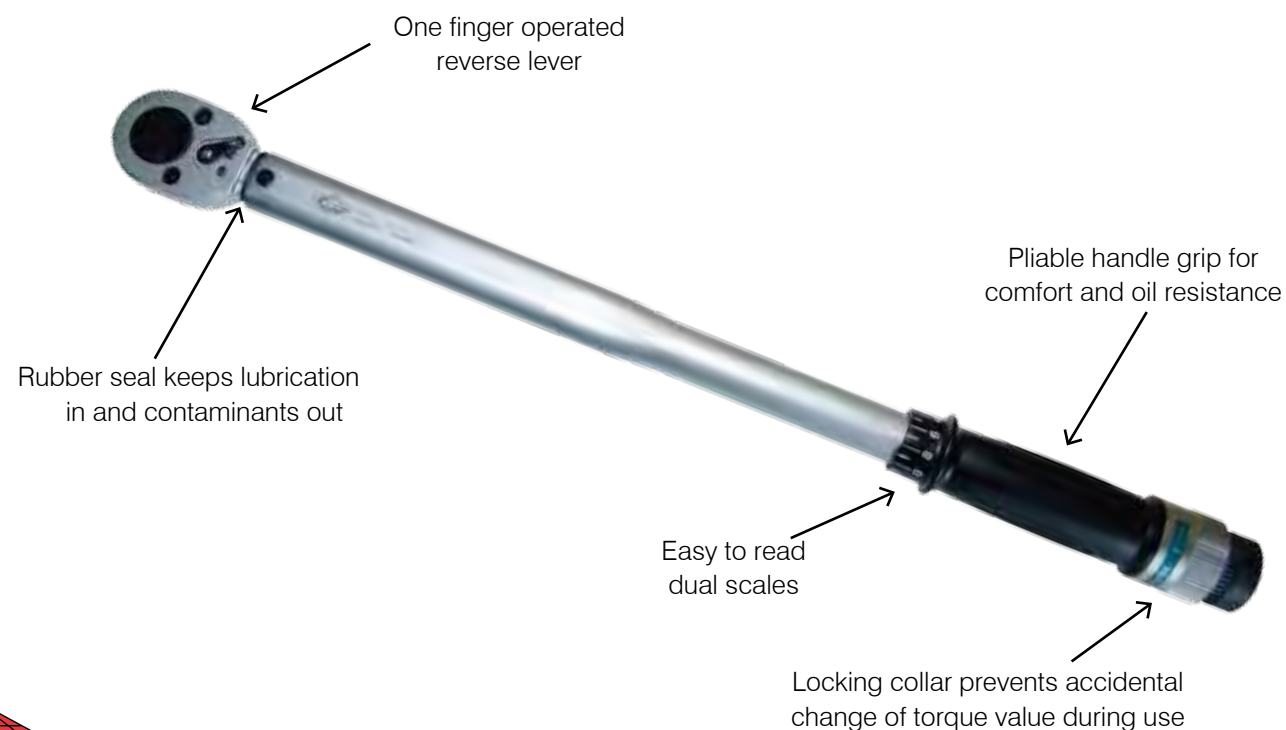

**1/4" DRIVE TORQUE WRENCH**

**MODEL 41050**



Primary Scale Range	Secondary Scale Range	Tooth Count	Head Thickness	Head Width	Overall Length	Weight (lbs)
40-250 in/lbs	5-28Nm	24	0.44"	1.14"	13.75"	1.63

**3/8" DRIVE TORQUE WRENCH**

**MODEL 41051**



Primary Scale Range	Secondary Scale Range	Tooth Count	Head Thickness	Head Width	Overall Length	Weight (lbs)
15-80 ft/lbs	20-108Nm	24	0.58"	1.44"	15.25"	2.11

**1/2" DRIVE TORQUE WRENCH**

**MODEL 41052**



Primary Scale Range	Secondary Scale Range	Tooth Count	Head Thickness	Head Width	Overall Length	Weight (lbs)
30-150 ft/lbs	40-203Nm	24	0.64"	1.85"	21.00"	3.75

**1" DRIVE TORQUE WRENCH**

**MODEL 41053**



Primary Scale Range	Secondary Scale Range	Tooth Count	Head Thickness	Head Width	Overall Length	Weight (lbs)
50-250 ft/lbs	67-339Nm	24	0.76"	1.85"	25.50"	5.60

**3/4" DRIVE TORQUE WRENCH**

**MODEL 41054**



Primary Scale Range	Secondary Scale Range	Tooth Count	Head Thickness	Head Width	Overall Length	Weight (lbs)
100-600 ft/lbs	135-813Nm	24	1.04"	2.85"	43.00"	13.07

**1" DRIVE TORQUE WRENCH**

**MODEL 41055**



Primary Scale Range	Secondary Scale Range	Tooth Count	Head Thickness	Head Width	Overall Length	Weight (lbs)
100-700 ft/lbs	135-949Nm	24	1.04"	2.85"	48.00"	14.21



**5 Pc Preset Torque Wrench Set**

**MODEL 42005**

- Includes 65, 80, 100, 120, and 140 ft/lb preset torque wrenches
- Individually tested and includes certificate of calibration
- Torque values are preset and require no adjustment before or after use
- Color coded for easy identification
- Covers majority of automotive and light truck applications
- Lightweight with ergonomic comfort grip
- Constructed with Chrome Vanadium Steel for professional use



**NEW PRODUCT!**

**15 pc Master Tire Service Kit**

**MODEL 42015**

- Kit includes the 42005 set plus the following accessories:
  - 40065 65 ft/lb torque limiting extension
  - 40080 80 ft/lb torque limiting extension
  - 40100 100 ft/lb torque limiting extension
  - 40120 120 ft/lb torque limiting extension
  - 40140 140 ft/lb torque limiting extension
  - 58001 6 pt deep 17mm mag wheel power socket
  - 58002 6 pt deep 19mm-3/4" mag wheel power socket
  - 58003 6 pt deep 21mm mag wheel power socket
  - 58004 6 pt deep 13/16" mag wheel power socket
  - 58005 6 pt deep 7/8" mag wheel power socket



**Mag Wheel Power Sockets**

- Specially designed for use on high end aluminum and chrome plated wheels
- Premium grade chrome molybdenum steel for professional use
- Plastic sleeve and inner cap to prevent scratches

**NEW PRODUCT!**



Model Number	Drive	Size
58001	1/2"	17mm
58002	1/2"	19mm
58003	1/2"	21mm
58004	1/2"	13/16"
58005	1/2"	7/8"

**1/2" Drive 65 ft/lb Preset Torque Wrench**

**MODEL 42065**

**NEW PRODUCT!**



Primary Scale Range	Secondary Scale Range	Color	Tooth Count	Overall Length	Ship Weight (lbs)
65 ft/lbs	88 Nm	Yellow	32	22.75"	4 lbs.

**1/2" Drive 80 ft/lb Preset Torque Wrench**

**MODEL 42080**



Primary Scale Range	Secondary Scale Range	Color	Tooth Count	Overall Length	Ship Weight (lbs)
80 ft/lbs	108 Nm	Blue	32	22.75"	4 lbs.

**1/2" Drive 100 ft/lb Preset Torque Wrench**

**MODEL 42100**



Primary Scale Range	Secondary Scale Range	Color	Tooth Count	Overall Length	Ship Weight (lbs)
100 ft/lbs	135Nm	Gray	32	22.75"	4 lbs.

**1/2" Drive 120 ft/lb Preset Torque Wrench**

**MODEL 42120**



Primary Scale Range	Secondary Scale Range	Color	Tooth Count	Overall Length	Ship Weight (lbs)
120 ft/lbs	163Nm	White	32	22.75"	4 lbs.

**1/2" Drive 140 ft/lb Preset Torque Wrench**

**MODEL 42140**



Primary Scale Range	Secondary Scale Range	Color	Tooth Count	Overall Length	Ship Weight (lbs)
140 ft/lbs	190Nm	Lt. Blue	32	22.75"	4 lbs.



**WHEEL BEARING LOCKNUT SOCKETS**

- For use with a ratchet or breaker bar
- Fits hexagonal 6 point, hexagonal rounded 6 point, and octagonal 8 point
- Machine welded 3/4" drive plate
- High tensile strength steel for added durability in high volume applications
- Laser etching for permanent identification and easy reading
- Chamfered edge design for easy on/off transition
- Powder coat finish provides added rust protection
- Precision engineered for exact fit and smooth operation
- Each socket individually boxed and labeled with bar code



MODEL	SIZE	MODEL	SIZE	MODEL	SIZE
18501	2-3/32"(6pt.)	18514	4" (6pt.)	18527	3-13/16" (8pt.)
18502	2-3/8"(6pt.)	18515	4-1/8" (6pt.)	18528	2-9/16"(6pt)
18503	2-3/8"(8pt.)	18516	4-3/8"(6pt.)	18532	2-7/8"(6pt.)
18504	2-9/16" (6pt.)	18517	4-3/8"(8pt.)	18533	2-7/8"(8pt)
18505	2-9/16"(8pt.)	18518	4-7/8"(6pt.)	18534	3-1/8"(6pt.)
18506	3" (6pt.)	18519	4-7/8"(8pt.)	18535	3-1/8"(8pt.)
18507	3" (8pt.)	18520	2-1/4" (6pt.)	18536	2-3/8"(6R)
18508	3-1/4" (6pt.)	18521	2-1/2"(6pt.)	18537	2-3/4"(8pt.)
18509	3-1/4" (8pt.)	18522	2-5/8" (6pt.)	18538	4-1/2"(8pt.)
18510	3-1/2" (6pt.)	18523	2-3/4" (6pt.)	18539	5-1/4"(6pt.)
18511	3-1/2"(8pt.)	18524	3-3/8" (8pt.)	18540	4-1/8"(8pt.)
18512	3-7/8"(6pt.)	18525	3-3/4" (8pt.)	18541	4-13/16"(8pt.)
18513	3-7/8"(8pt.)	18526	3-3/4" (6pt.)		

**COMBINATION 2 AND 3 JAW REVERSIBLE GEAR PULLERS**

**Model 57000, 57001, 57002, 57003**

- Reversible jaw design allows for internal or external pulling
- Includes 3 jaws for maximum stability or can be converted to 2 jaws where space is limited
- Jaws, yoke, and forcing screw made of heat treated Chrome Vanadium for ultimate strength
- Ideal for use with crankshaft pulleys and other Heavy Duty and Automotive applications
- Forcing screw can be tightened with a wrench or ratchet



MODEL	DESCRIPTION	REACH	SPREAD	CAPACITY	SHIP WEIGHT
57000	3" Gear Puller	3-1/4"	4-3/4"	2 ton	2.20 lbs
57001	4" Gear Puller	3-1/4"	7"	5 ton	3.25 lbs
57002	6" Gear Puller	5-1/2"	7"	5 ton	4.00 lbs
57003	8" Gear Puller	5-1/2"	9-1/2"	3 ton	7.17 lbs

**MAGNETIC PARTS TRAY CIRCULAR**

**MODEL 920**

- Prevents loss of sockets, bits, bolts, and nuts
- Retracts down to 1-1/4" for easy storage
- Rubber cover provides scratch resistance
- Works upside down
- Dimensions: 5" length x 6" wide
- Ship weight .28 lbs



**MAGNETIC PARTS TRAY OVAL**

**MODEL 921**

- Prevents loss of sockets, bits, bolts, and nuts
- Retracts down to 1-3/8" for easy storage
- Rubber cover provides scratch resistance
- Works upside down
- Dimensions: 12" length x 9" wide
- Ship weight 1.32 lbs



**AFF 5 GALLON BUCKET**

**MODEL AFFBUCKET**

- Durable plastic construction
- Provides general storage for a variety of items
- Equipped with a strong metal handle
- Locking lid included
- Ship weight 2.0 lbs





American Forge & Foundry offers a family of air tools that focus on quality and value. Our classic design is constructed with a special tungsten and titanium alloy to provide long lasting service, and an aluminum hammer casing offers durability and protection. Each is ideal for heavy duty and tire shop applications.

### 1/2" AIR IMPACT WRENCH

#### MODEL 7660

- Aluminum hammer casing for greater durability and protection
- Convenient forward/reverse switch for quick directional changes
- Adjustable throttle settings for maximum control
- Hammer and anvil constructed of special tungsten and titanium alloy to provide greater service life

#### SPECIFICATIONS:

- 7660: Short Anvil
- 7665: 2" Extended Anvil
- Max. Torque (ft/lbs) - Reverse: 550
- Working Torque (ft/lbs) - Reverse: 25-550
- Free Speed (RPM): 7,000
- Avg. Air Consumption (cfm): 8
- Overall Length: 7"
- Min. Hose Size: 3/8"
- Air Inlet (NPT): 1/4"
- Sound Pressure (dBA): 90
- Product Weight: 5.5 lbs

### 1/2" AIR IMPACT WRENCH WITH 2" EXTENDED ANVIL

#### MODEL 7665



### 3/4" AIR IMPACT WRENCH

#### MODEL 7670

- Aluminum hammer casing for greater durability and protection
- Convenient forward/reverse switch for quick directional changes
- Three forward and one reverse speed for maximum control
- Hammer and anvil constructed of special tungsten and titanium alloy to provide greater service life

#### SPECIFICATIONS:

- Square Drive: 3/4"
- Max. Torque (ft/lbs) - Reverse: 956
- Working Torque (ft/lbs) - Reverse: 360-390
- Free Speed (RPM): 5,000
- Avg. Air Consumption (cfm): 7
- Overall Length: 9-1/2"
- Min. Hose Size: 1/2"
- Air Inlet (NPT): 3/8"
- Sound Pressure (dBA): 92
- Product Weight: 10.25 lbs



### 1" D-HANDLE AIR IMPACT WRENCH

#### MODEL 7685

- Produces 1,912 ft-lbs of hard hitting torque
- Rocking dog hammer mechanism for power and durability
- 6" extended anvil for easier reach
- Three forward and three reverse speeds for maximum control
- Ideal for agricultural and general shop applications

#### SPECIFICATIONS:

- Square Drive: 1" with 6" extended anvil
- Max. Torque (ft/lbs) - Reverse: 1,912
- Working Torque (ft/lbs) - Reverse: 1,500-1,650
- Free Speed (RPM): 4,000
- Avg. Air Consumption (cfm): 10
- Overall Length: 21-1/4"
- Min. Hose Size: 1/2"
- Air Inlet (NPT): 1/2"
- Sound Pressure (dBA): 103
- Product Weight: 28.7 lbs



### 3/8" DRIVE AIR RATCHET

#### MODEL 7010

- Ideal for exhaust system work, air conditioner, water and fuel pump, and general engine and body shop work
- Fast 150 RPM head and powerful torque output
- Ball type socket retainer allows for quick socket changes
- Durable aluminum housing
- Intake screen protects motor for extended shop life

#### SPECIFICATIONS:

- Max torque by hand (reverse): 70 ft-lbs
- Max torque by air (reverse): 50 ft-lbs
- Free Speed (RPM): 150
- Avg. Air Consumption (cfm): 4
- Overall length: 10-1/4"
- Min. Hose Size: 3/8"
- Air Inlet (NPT): 1/4"
- Product Weight: 2.46 lbs



### 1/2" DRIVE AIR RATCHET

#### MODEL 7020

- Ideal for exhaust system work, air conditioner, water and fuel pump, and general engine and body shop work
- Fast 150 RPM head and powerful torque output
- Ball type socket retainer allows for quick socket changes
- Durable aluminum housing
- Intake screen protects motor for extended shop life

#### SPECIFICATIONS:

- Max torque by hand (reverse): 70 ft-lbs
- Max torque by air (reverse): 50 ft-lbs
- Free Speed (RPM): 150
- Avg. Air Consumption (cfm): 4
- Overall length: 10-1/4"
- Min. Hose Size: 3/8"
- Air Inlet (NPT): 1/4"
- Product Weight: 2.46 lbs





### .3HP 1/4" MINI DIE GRINDER

#### MODEL 7150

- Long service life features: steel end plate inserts, brass collar, reinforced air inlet and cylinder made of higher quality steel
- Mini length housing and lever throttle control with roller
- Rear exhaust and built in air regulator

#### SPECIFICATIONS:

- Collet size: 1/4"
- Free Speed (RPM): 25,000
- Avg. Air Consumption (cfm): 4
- Overall Length: 6-3/16"
- Min. Hose Size: 3/8"
- Air Inlet (NPT): 1/4"
- Sound Pressure (dBA): 90
- Product Weight: .85 lbs



### .3HP 1/4" MINI DIE GRINDER - 90° ANGLED HEAD

#### MODEL 7151

- Mini length housing with angled head Long service life features: steel end plate inserts, brass collar, reinforced air inlet and cylinder made of higher quality steel
- Lever throttle control with roller
- Rear exhaust and built in air regulator

#### SPECIFICATIONS:

- Collet size: 1/4"
- Free Speed (RPM): 18,000
- Avg. Air Consumption (cfm): 5
- Overall length: 5-3/16"
- Min. Hose Size: 3/8"
- Air Inlet (NPT): 1/4"
- Sound Pressure (dBA): 103
- Product Weight: 1.05 lbs



### .6HP 1/4" HEAVY DUTY MINI DIE GRINDER

#### MODEL 7160

- Powerful .6HP motor
- Motor shaft features ball bearings front and back, and motor end plates are made from durable diecast aluminum
- Insulating vinyl cover wraps aluminum case for comfort
- Lever throttle control with roller tip
- Ideal for most heavy duty industrial applications

#### SPECIFICATIONS:

- Collet size: 1/4"
- Free Speed (RPM): 20,000
- Avg. Air Consumption (cfm): 4.5
- Overall length: 5-3/4"
- Min. Hose Size: 3/8"
- Air Inlet (NPT): 1/4"
- Sound Pressure (dBA): 95
- Product Weight: 1.35 lbs



### .6HP 1/4" HEAVY DUTY MINI DIE GRINDER - 90° ANGLED HEAD

#### MODEL 7161

- Powerful .6HP motor with angled head for greater versatility
- Motor shaft features ball bearings front and back, and motor end plates are made from durable diecast aluminum
- Insulating vinyl cover wraps aluminum case for comfort Lever throttle control with roller tip
- Ideal for most heavy duty industrial applications

#### SPECIFICATIONS:

- Collet size: 1/4"
- Free Speed (RPM): 14,500
- Avg. Air Consumption (cfm): 5
- Overall length: 7-1/2"
- Min. Hose Size: 3/8"
- Air Inlet (NPT): 1/4"
- Sound Pressure (dBA): 95
- Product Weight: 2 lbs



### .6HP 1/4" HEAVY DUTY MINI DIE GRINDER - 6" EXTENDED

#### MODEL 7162

- Powerful .6HP motor with extended nose for greater reach
- Motor shaft features ball bearings front and back, and motor end plates are made from durable diecast aluminum
- Insulating vinyl cover wraps aluminum case for comfort
- Lever throttle control with roller tip
- Ideal for most heavy duty industrial applications

#### SPECIFICATIONS:

- Collet size: 1/4"
- Free Speed (RPM): 20,000
- Avg. Air Consumption (cfm): 4.5
- Overall length: 12"
- Min. Hose Size: 3/8"
- Air Inlet (NPT): 1/4"
- Sound Pressure (dBA): 93
- Product Weight: 2.72 lbs



### 4" ANGLE GRINDER

#### MODEL 7100

- Light weight and compact design with a heavy duty .8HP motor
- Durable aluminum housing with side handle for extra control
- Self-locking throttle lever prevents accidental start-ups
- Includes: wheel guard, wrenches, and grinding wheel

#### SPECIFICATIONS:

- Wheel Diameter: 4"
- Free Speed (RPM): 11,000
- Avg. Air Consumption (cfm): 6
- Overall length: 8.75"
- Min. Hose Size: 3/8"
- Air Inlet (NPT): 1/4"
- Sound Pressure (dBA): 91
- Product Weight: 4 lbs





American Forge & Foundry offers a wide variety of lubrication tools, drains, and pumps to fit the demanding needs of any Heavy Duty or Automotive professional. Each are engineered with tight fittings, durable components, and quality material for years of trouble free service.

**50:1 AIR OPERATED PORTABLE GREASE UNIT  
MODEL 8600A**

- For use with 5-gallon (35 lb.) containers
- 50:1 pump
- 70-100 PSI operating pressure
- Pumps up to 1.76 lbs. per minute
- 82 dB noise level
- Carrying handle
- 13' delivery hose
- 12.20" drum cover
- Control valve
- Ship weight 23 lbs.



**REPLACEMENT PUMPS**

**MODEL 8600AP**

- 50:1 Air-operated grease pump only for use with 5-gallon (35 lb.) containers.
- 70-100 PSI operating pressure
- Pumps up to 1.76 lbs. per minute
- 82dB noise level
- Ship weight 12 lbs.

**MODEL 8620AP**

- 50:1 Air-operated grease pump only for use with 16-gallon (120 lb.) containers.
- Ship weight 14 lbs.

**50:1 AIR OPERATED PORTABLE GREASE UNIT  
MODEL 8620A**

- For use with 16-gallon (120 lbs) containers
- 50:1 pump
- 70-100 PSI operating pressure
- Pumps up to 1.76 lbs. per minute
- 82 dB noise level
- 13' delivery hose
- 15.10" drum cover
- 14-1/2" follower plate
- Control valve
- Ship weight 38 lbs.



8621A is 8620A+Band Dolly

**AIR OPERATED PORTABLE GREASE UNIT WITH MODEL 8625 BAND DOLLY  
MODEL 8621A**

- Same as 8620A (see specs above)
- Includes 8625 Band Dolly
- Ship weight 38 lbs.

**AIR OPERATED PORTABLE GREASE UNIT WITH MODEL 4-WHEEL CART  
MODEL 8622A**

- Same as 8620A (see specs above)
- Includes 4-wheel cart
- Ship weight 54 lbs.



8622A is 8620A+Cart

**PROFESSIONAL DUTY GREASE GUN**

**MODEL 8000**

- 10,000 PSI
- 14 oz. capacity via cartridge suction or bulk loading
- Heavy duty aluminum diecast head
- Bulk loader and air bleeder valve
- Four-jaw coupler with ball check
- Ship weight 4 lbs.



**STANDARD GREASE GUN**

**MODEL 8002**

- 8,000 PSI
- Four-jaw coupler with ball check
- 14 oz. capacity via cartridge or suction
- Ship weight 4 lbs.



**PISTOL GRIP GREASE GUN**

**MODEL 8003**

- 5,000 PSI with flexible hose
- Comfortable one-hand operation in confined spaces
- Heavy duty aluminum diecast head
- Four-jaw coupler with ball check
- 14 oz. capacity via cartridge or suction
- Ship weight 4 lbs.



**COLD WEATHER GREASE GUN**

**MODEL 8004**

- Large grease inlet allows better functionality even in cold weather
- Capacity: 14 oz cartridge or 500cc bulk fill
- 18" high pressure flex hose and 4-jaw coupler
- 7500 PSI
- Ship weight 3.5 lbs.



**CONTINUOUS FLOW AIR GREASE GUN**

**MODEL 8605**

- Continuous flow with trigger pressed
- Cartridge, bulk, or suction loading
- 6" ext and 12" hose/coupler included
- 4,800 PSI
- Ship weight 4.5 lbs.



**SUCTION GUN**

**MODEL 8006**

- Transfers gear oils into and out of gear boxes, transfer cases and differentials.
- Single piece aluminum diecast head
- 12" flexible vinyl hose
- 16 oz. capacity
- Ship weight 2 lbs.





### DELUXE MINI PISTOL GREASE GUN

#### MODEL 8007

- 3,500 PSI
- One-hand operation
- Aluminum diecast head with front and top discharge ports
- Four-jaw coupler with ball check
- 3 oz. capacity
- Ship weight 5 lbs.



### PNEUMATIC GREASE GUN

#### MODEL 8010

- 4,800 PSI
- 14 oz. capacity via cartridge, suction or bulk loading
- Single shot with every trigger pull
- Heavy-duty aluminum diecast head
- 40:1 pressure ratio
- Four-jaw coupler
- Bulk loader valve
- Ship weight 5 lbs.



### PISTOL OIL CAN

#### MODEL 8040

6 oz. Pistol style



### LONG NECK OIL CAN

#### MODEL 8041

6 oz. Long neck

### OIL CAN

#### MODEL 8042

7 oz. with 4" straight and flexible spouts



### OIL CAN

#### MODEL 8043

10 oz. with 4" straight and flexible spouts

### OIL CAN

#### MODEL 8044

16 oz. with 4" straight and flexible spouts



### GREASE FITTING KITS

#### MODEL 8103 & 8104

- Replacements for broken or damaged grease fittings
- Kit contains 80 individual grease fittings contained in a plastic case.
- Ship weight 1 lbs.

#### MODEL 8103 (SAE)

Thread spec/contents:  
 1/8"-25 NPT:  
 25 each straight  
 10 each 45°  
 10 each 90°

1/4"-28 SAE-LT:  
 15 each straight  
 10 each 45°  
 10 each 90°

#### MODEL 8104 (Metric)

Thread spec/contents:  
 M6x1: 20 straight,  
 10 each 90°  
 M8x1: 15 straight,  
 10 each 90°  
 M10x1: 15 straight,  
 10 each 90°



### FLUID TRANSFER GUN

#### MODEL 8005

- Transfers liquids from one container to another
- 8 ft. of vinyl hose (4 ft. for each valve)
- Suitable for petroleum products
- 16 oz. capacity
- Ship weight 3 lbs.



### 7 PC LUBRICATION KIT

#### MODEL 8090

- 8014: Whip hose with quick disconnect (QD) and heavy duty coupler
- 8025: Recessed QD lube adapter
- 8037: Rubber-tipped QD seal-off dispenser
- 8022: 1-1/2" narrow needle adapter (QD)
- 8034: Right angle adapter (QD)
- 8021: 90° adapter (QD)
- 8091: Needle adapter
- Cloth roll up pouch for storage
- Ship weight 2 lbs.



### GREASE FITTING UNBLOCKER

#### MODEL 8100

- Opens clogged grease fittings and loosens hardened grease joints
- Tapping tool with a hammer forces a light viscosity oil into the fitting, breaking up and removing dirt and debris
- Excellent for maintaining bearings, control arms, king pins etc.
- Built-in hand guard for operator protection
- Complete with coupler and flex hose for reaching recessed fittings
- Includes 2 spare piston seals
- Ship weight 1.5 lbs



### GREASE GUN WHIP HOSES

#### MODEL 8012 - 12"

#### MODEL 8018 - 18"

- For hand-operated grease guns
- 3,500 PSI working pressure
- 11,600 PSI burst pressure
- 1/8" NPT threads

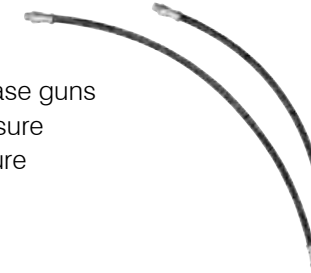

### HEAVY DUTY GREASE GUN WHIP HOSES

#### MODEL 8013 - 12"

#### MODEL 8019 - 18"

- Heavy duty spring guard for added durability/safety
- For hand-operated grease guns
- 3,500 PSI working pressure
- 11,600 PSI burst pressure
- 1/8" NPT threads

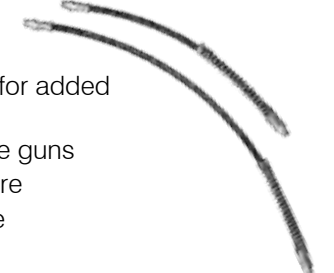

### QUICK DISCONNECT GREASE GUN WHIP HOSE

#### MODEL 8014 - 12"

- Quick disconnect
- Heavy duty coupler
- For hand-operated grease guns
- 3,500 PSI working pressure
- 11,600 PSI burst pressure
- 1/8" NPT threads



### HIGH PRESSURE GREASE GUN HOSES

#### MODEL 8612 - 12"

#### MODEL 8618 - 18"

- Polyamide inner tube with polyurethane sheathing
- 0.425" outer diameter
- 5,800 PSI working pressure (13,775 PSI burst)
- Zinc-plated end connections
- 1/8" NPT threads



### 90° LUBE ADAPTER (QD)

#### MODEL 8021

- Reach hidden fittings in shoulders & confined areas
- 0.24" greasing end diameter
- Locking sleeve
- For hand-operated grease guns only



### 1-1/2" NARROW NEEDLE ADAPTER (QD)

#### MODEL 8022

- Reach flush or hidden fittings
- 0.156" needle diameter
- Locking sleeve
- For hand-operated grease guns only



### GREASE CONTROL VALVE

#### MODEL 8698

- Continuous grease flow with trigger depressed
- 1/4" NPT (f) inlet and 1/8" NPT (f) outlet threads
- For power lube equipment
- Ship weight 2 lbs.

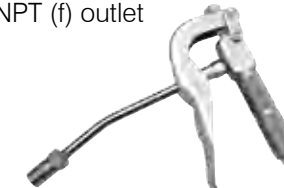

### 360° "Z" SWIVELS 1/4" NPT (m) x 1/2" 27 (m)

#### MODEL 8686

### 360° "Z" SWIVELS 1/4" NPT (m) x 1/4" NPT (m)

#### MODEL 8687

Heavy-duty steel installed between delivery hose and grease control valve prevents hose twisting





**4" NEEDLE ADAPTER (QD)**  
**MODEL 8023**

- Dispense a fine line of grease
- For hand-operated grease guns only



**QUICK DISCONNECT (QD) ADAPTER**  
**MODEL 8024**

- Grease fitting on one end and 1/8" NPT threads on the other
- For hand-operated grease guns only



**RECESSED LUBE ADAPTER (QD)**  
**MODEL 8025**

- For recessed fittings where hydraulic couplers can't reach
- Cup-shaped 0.22" diameter tip
- 0.31" body diameter, 3.15" length
- Locking sleeve
- For hand-operated grease guns only



**BULK LOADER VALVE**  
**MODEL 8026**

- Replacement valve for hand-operated grease guns only



**1-1/2" NEEDLE ADAPTER**  
**MODEL 8027**

- Use to dispense a fine line of grease
- Reach flush or hidden hydraulic type fittings
- For hand-operated grease guns only
- 1/8" NPT threads



**NEEDLE ADAPTERS**  
**MODEL 8028 - 5/8"**

- Use to dispense a fine line of grease
- Reach flush or hidden hydraulic type fittings
- For hand-operated grease guns only
- 1/8" NPT threads
- Zinc-plated end connections



**NEEDLE ADAPTERS**  
**MODEL 8029 - 6"**

- Use to dispense a fine line of grease
- Reach flush or hidden hydraulic type fittings
- For hand-operated grease guns only
- 1/8" NPT threads
- Zinc-plated end connections



**GREASE GUN EXTENSION**  
**MODEL 8030**

- 6" length
- 1/8" NPT threads



**GREASE GUN HOLDER**  
**MODEL 8031**

- Snap-action clamp for easy grease gun storage
- Standard (3,000 PSI)



**HYDRAULIC COUPLER**  
**MODEL 8032**

- Standard (3,000 PSI)



**HYDRAULIC COUPLER**  
**MODEL 8033**

- Professional (6,000 PSI)
- Four-jaw coupler with ball check
- For hand-operated grease guns only



**RIGHT-ANGLE GREASE COUPLER**  
**MODEL 8034**

- Polyurethane seal fits perfectly on fittings
- Hardened coupler housing slot provides 90° access
- For hand-operated grease guns only
- 1/8" NPT threads



**3-JAW SWIVELING COUPLER**  
**MODEL 8035**

- 360° swivel locks in any of eight 45° positions
- Adjustable coupler section
- 7,000 PSI maximum operating pressure



**BEARING PACKER**  
**MODEL 8036**

- For greasing taper roller bearings with 1/2" min. inner diameter, 5" maximum outside diameter & height from 1/4" to 2"
- For hand operated or power lube equipment



**SEAL-OFF DISPENSER**  
**MODEL 8037**

- For lubricating cars with grease plugs
- For hand-operated grease guns only
- Threaded 1/8" female NPT



**FINE-POINT NEEDLE ADAPTER**  
**MODEL 8091**

- For dispensing very fine line of grease
- Sharp point to inject grease into ball joints
- For hand-operated grease guns only



**LEVER ACTION BARREL PUMP**  
**MODEL 8055**

- For use with: DEF, water based media, detergents, soaps, antifreeze, etc.
- Designed to pump high viscosity oils
- Anti-siphon vent cap
- Delivers 1 pint (500ml) per stroke
- Pump includes suction tube for use with 15-55 gallon drums and a 3'x3/4" flexible discharge hose
- Wetted Components: polyacetal, polypropylene, polyethylene, PVC, Viton
- Ship weight 3.4 lbs



**E-Z FLOW 5 GALLON OIL PUMP**  
**MODEL 8060**

- Designed for containers with Rieke or regular openings
- High density polyethylene pump head with steel suction tube
- Interchangeable bung adapters
- Rigid steel outlet spout and 48" discharge tube
- Use for transfer of oils, diesel fuel and 100% antifreeze
- Delivers 1 quart per 15 strokes
- Ship weight 2 lbs.



**CHEMICAL PUMP - NYLON BODY**  
**MODEL 8064**

- Self priming vertical lift pump
- Nylon pump with stainless steel plunger rod and Teflon seals.
- Complete with 2" polypropylene bung adapter
- Excellent for use with lacquer thinners, acetone, antifreeze, brake klean detergents, glycerin, water, etc.
- Fits 15-55 gallon drums
- Delivers 14 oz. per stroke
- DEF compatible
- Ship weight 3 lbs.



**15-55 GALLON HAND ROTARY PUMP**  
**MODEL 8070**

- Cast iron pump housing with heavy duty cast vanes and nitrite rubber seals
- Three-section 37-1/4" telescopic suction tube with interchangeable bung adapters
- Use for diesel fuel and non-corrosive petroleum-based fluids of light to medium viscosity
- Ship weight 14 lbs.

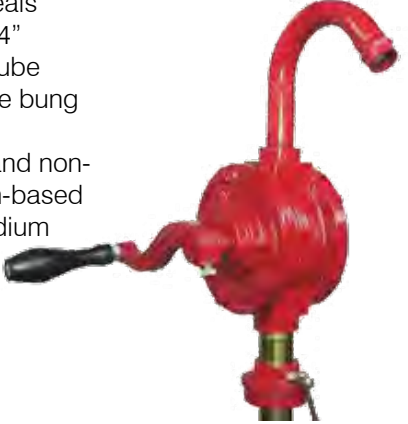

**HIGH VOLUME ALUMINUM ROTARY PUMP**  
**MODEL 8071**

- Delivers over one quart per revolution
- Long lasting diecast aluminum construction with cast aluminum Buna-N-Seals
- Powder coated finish with zinc plated handle and discharge spout
- Curved metal spout, suction tube and bung adapter
- Use for transfer of petroleum-based products
- Ship weight 13 lbs.



**POLYPROPYLENE ROTARY BARREL PUMP**  
**MODEL 8075**

- High density polypropylene with Rytan vanes
- 3 pc extension tube with filter and 2" bung adapter
- Use with water, water-based chemicals, 50/50 antifreeze mix, windshield washer solvents, alcohol, and petroleum-based products
- Works with DEF fluid
- Ship weight 5 lbs.





### ROTARY DEF PUMP

#### MODEL 8076

- Specifically designed for use with diesel exhaust fluid (DEF,) AdBlue, and Urea
- Constructed with high density polypropylene with polypropylene vanes
- Delivers 1.3 gallons per 20 revolutions
- 3 pc extension suction tube with strainer fits 15-55 gallon drums
- 2" bung adapter included
- Ship weight 5 lbs



### FM APPROVED ROTARY FUEL PUMP

#### 8210

- Conforms to highest national and international standards
- Allows quick refueling of vehicles and equipment
- Self-priming operation with vacuum release
- Graphite vanes are self-lubricating and nonwearing
- Includes 8' anti-static hose with non-sparking nozzle
- Ship weight 19 lbs



### LEVER ACTION 15-55 GALLON BARREL PUMP FOR GAS/DIESEL

#### MODEL 8080

- For use with petroleum-based fluids
- Hi-Nitrile rubber seals and packing
- Durable steel piston and foot valve
- Curved metal spout, 34-1/2" telescopic suction tube with 1-1/2" and 2" bung adapters. Use with oil-based fluids, heating oils and motor oils
- Delivers 10 oz. per stroke
- Ship weight 5 lbs.



### LEVER ACTION 15-55 GALLON ANTIFREEZE BARREL PUMP

#### MODEL 8081

- Same as 8080 but designed for use with 100% antifreeze, noncorrosive chemicals, oils, and petroleum based fluids.

### BUNG NUT ADAPTER

#### MODEL 8077

- 2" bung hole adapter converts buttress threaded drum opening to 2" NPT thread permitting easy application of various AFF pumps.
- A Buttress thread can be found on plastic drums used with DEF fluid, antifreeze, washer solvent, and other liquid media.



### BULK GREASE FILLER PUMP

#### MODEL 8038

- Fill grease guns through a bulk loader valve or with a bearing packer
- Fits 5-gallon (25-50 lb.) pails
- 11 1/8" rubber-lined follower plate
- Ship weight 5 lbs.



### HIGH-PRESSURE (3500 PSI) GREASE PUMP

#### MODEL 8039

- Fits 5-gallon (25-50 lb.) pails
- Steel construction with aluminum head and pumping chamber
- Includes 12' drum cover, 11-1/8" rubber-lined follower plate
- 48" high-pressure flexible hose with steel extension and four-jaw coupler
- Use for clean, high-pressure volume greasing of cars, trucks, equipment and machinery
- Ship weight 9 lbs.



Pail Not Included



### BUCKET LEVER PUMPS

#### MODEL 8050

5 Gallon (25 to 50 lbs)

#### MODEL 8051

16 Gallon (120 lbs)

- Designed for use with differential fluids or heavier oils
- 48" fuel-resistant PVC hose with nozzle
- Delivers 1 pint per stroke
- Ship weight 5 lbs. (Model 8050)
- Ship weight 9 lbs. (Model 8051)



### LOW PROFILE STEEL OIL DRAIN

#### MODEL 8877

- Ideal for draining oil where a pit or hoist is not available
- 15 gallon capacity
- Large metal screen provides extra draining area and keeps out debris
- Convenient rotary hand pump for fast evacuation



### LOW PROFILE WASTE OIL DRAIN

#### MODEL 8878

- Low profile drain height of 7.75"
- Large 18 gallon baffled tank reduces "slosh" during transport
- Large metal screen provides extra draining area and keeps out debris
- Convenient rotary hand pump for fast evacuation
- Long steel handle provides easy mobility to drain area
- Ship weight 47 lbs



### 12V DC POWERED PUMP FOR 8878

#### MODEL 8815

- Replaces rotary pump on 8878 Low Profile Oil Drain
- Operates on DC power (from 12V battery or battery tester)
- Easy to use on/off switch and alligator style power leads
- Includes all fittings and hardware



### LOW PROFILE ANTIFREEZE DRAIN

#### MODEL 8879

- Ideal for draining antifreeze where a pit or hoist is not available
- Large 18 gallon baffled tank reduces "slosh" during transport
- Large metal screen provides extra draining area and keeps out debris
- Convenient rotary hand pump for fast evacuation
- Aluminum design keeps antifreeze from corroding inner components
- Ship weight 46 lbs





**8 GALLON WASTE OIL DRAIN WITH METAL TROLLEY**

**MODEL 8870**

- 8 gallon capacity
- Plastic drain container
- Comes with 16.5" funnel
- Extends from 34" to 65"
- Metal trolley comes with 4 casters and pull handle for safe and easier movement around the shop.
- Ship weight 18 lbs.



**18 GALLON WASTE OIL DRAIN WITH METAL TROLLEY**

**MODEL 8874**

- 18 gallon capacity
- Plastic drain container
- Comes with 16.5" funnel
- Extends from 40" to 73"
- Metal trolley comes with 4 casters and pull handle for safe and easier movement around the Shop.
- Oil can be drained either by pour gravity, integrated drain valve or using integrated bung hole rotary barrel pump (not included)
- Ship weight 24 lbs.



**CANTILEVER WASTE OIL DRAIN/EVACUATOR**  
**MODEL 8888**

- Unique design operates as an evacuator OR pressurized drain
- Ideal when oil extraction is preferred over oil drainage
- Pressurized air/suction transfers drained oil directly from basin to tank
- Suction probes evacuate oil directly from vehicle to tank
- Includes 6 individual suction probes along with special connectors for BMW and VW
- 23.75 gallon tank capacity with 17 gallon basin capacity
- Ship weight 123 lbs



**24 GALLON WASTE OIL DRAIN AND PRESSURIZED EVACUATOR**

**MODEL 8890**

- Large 24 gallon steel recovery tank with 6' drain hose
- Tank-mounted oil-level sight gauge and convenient tool tray
- Standard 15-3/4" drain funnel and wide 24" funnel adapter (shown) with drain tube that extends from 54" to 79"
- Pressure regulator
- Heavy duty wheels and casters
- Ship weight 82 lbs.



**REPLACEMENT STANDARD PLASTIC FUNNEL**

**MODEL 8890K08**

- Fits AFF Model 8890 24 Gallon Waste Oil Drain and Pressurized Evacuator.
- 15-3/4" wide
  - Ship weight 8 lbs.

**18 GALLON WASTE OIL DRAIN WITH AIR EVACUATION**

**MODEL 8893**

- 18 gallon steel recovery tank with 6' wire reinforced drain hose.
- Tank mounted oil level sight gauge
- Standard 14" x 5" deep drain funnel
- Extendable drain tube from 43.5" to 71"
- Preset pressure regulator
- Heavy duty wheels and casters
- Ship weight 66 lbs.



**24 GALLON WASTE OIL DRAIN AND EVACUATOR WITH PROBE KIT**

**MODEL 8895**

- 18 gallon suction capacity
- 100 PSI shop air connected to vacuum gauge quickly creates suction
- Large 16" collection funnel (4-7/8 gallon capacity)
- Suction extraction at 1/2 gallon per minute
- 78" suction and drain hoses
- Pressurized evacuation of tank makes emptying easy
- 70.8" maximum height
- Six flexible evacuation probes and VW, Mercedes and BMW adapters
- Two air ports: 1 for pressure, 1 for vacuum
- Ship weight 93 lbs.



**3 LITER AXLE OIL DRAIN PAN**

**MODEL 8830**

- For use with wheels ranging from 13.75" I.D. and larger
- Catches oil from hubs after removing the cap
- Fits on the rims of buses, trailers, and large trucks
- Prevents messy oil spills during wheel repair
- Side opening is designed for easy pouring into collector
- Durable polypropylene design
- Ship weight 1 lb



**5 LITER AXLE OIL DRAIN PAN**

**MODEL 8831**

- For use with wheels ranging from 19" I.D. and larger
- Catches oil from hubs after removing the cap
- Fits on the rims of buses, trailers, and large trucks
- Prevents messy oil spills during wheel repair
- Side opening is designed for easy pouring into collector
- Durable polypropylene design
- Ship weight 1.43 lbs





AFF Model Number	PUMP CAPABILITY CHART												
	8050	8051	8055	8060	8064	8070	8071	8075	8076	8080	8081	8210	
<b>Chemical</b>													
Acetaldehyde	NO	NO	NO	NO	SOME	NO	NO	NO	NO	NO	NO	NO	NO
Acetic acid 20%	NO	NO	NO	NO	NO	NO	NO	SOME	OK	NO	NO	NO	NO
Acetone	NO	NO	NO	NO	OK	NO	NO	NO	NO	NO	NO	NO	NO
Alcohol: Amyl	NO	NO	SOME	SOME	OK	SOME	SOME	SOME	OK	SOME	SOME	OK	OK
Alcohol: Benzyl	NO	NO	NO	NO	OK	NO	NO	SOME	OK	NO	NO	NO	NO
Alcohol: Butyl	NO	NO	SOME	SOME	OK	SOME	SOME	SOME	OK	SOME	SOME	SOME	SOME
Alcohol: Diacetone	NO	NO	NO	NO	OK	NO	NO	NO	NO	NO	NO	NO	NO
Alcohol: Ethyl	SOME	SOME	SOME	SOME	OK	SOME	SOME	OK	NO	SOME	SOME	SOME	SOME
Alcohol: Hexyl	SOME	SOME	SOME	SOME	OK	SOME	SOME	SOME	NO	SOME	SOME	SOME	SOME
Alcohol: Isobutyl	SOME	SOME	SOME	SOME	OK	SOME	SOME	SOME	NO	SOME	SOME	SOME	SOME
Alcohol: Isopropyl	SOME	SOME	SOME	SOME	OK	SOME	SOME	SOME	NO	SOME	SOME	OK	OK
Alcohol: Methyl	SOME	SOME	NO	NO	OK	SOME	SOME	NO	SOME	SOME	SOME	OK	OK
Alcohol: Propyl	SOME	SOME	NO	NO	OK	OK	SOME	OK	OK	SOME	SOME	OK	OK
Ammonia, 10%	NO	NO	NO	NO	NO	NO	NO	OK	NO	NO	NO	NO	NO
Ammonia, anhydrous	NO	NO	NO	NO	NO	NO	NO	NO	NO	NO	NO	NO	NO
Ammonia, liquid	NO	NO	NO	NO	NO	NO	NO	NO	NO	NO	NO	NO	NO
Ammonium Hydroxide	NO	NO	NO	NO	NO	NO	NO	SOME	OK	NO	NO	NO	NO
Anti-freeze	NO	NO	OK	OK	OK	NO	NO	OK	NO	NO	OK	OK	NO
Benzene	NO	NO	NO	NO	NO	NO	NO	OK	NO	NO	NO	NO	NO
Benzoic Acid	NO	NO	NO	SOME	OK	NO	NO	NO	OK	NO	NO	NO	NO
Bleach	NO	NO	NO	NO	NO	NO	NO	NO	NO	NO	NO	NO	NO
Boric Acid	NO	NO	SOME	SOME	OK	NO	NO	OK	OK	NO	NO	NO	NO
Calcium Chloride(30% in water)	NO	NO	NO	NO	NO	NO	NO	NO	OK	NO	NO	NO	NO
Calcium Hypochlorite	NO	NO	NO	NO	NO	NO	NO	NO	OK	NO	NO	NO	NO
Calcium Sulfate	SOME	SOME	SOME	SOME	OK	NO	NO	OK	OK	SOME	SOME	NO	NO
Citric Acid	NO	NO	SOME	SOME	NO	NO	NO	SOME	OK	NO	NO	NO	NO
Copper Chloride	NO	NO	SOME	SOME	NO	NO	NO	NO	NO	NO	NO	NO	NO
Copper Sulfate(5%)	NO	NO	SOME	SOME	NO	NO	NO	OK	OK	NO	NO	NO	NO
DEF/Urea	NO	NO	OK	NO	OK	NO	NO	SOME	OK	NO	NO	NO	NO
Detergents	NO	NO	OK	OK	OK	NO	NO	OK	OK	NO	NO	NO	NO
Diesel Fuel	OK	OK	NO	OK	OK	OK	OK	NO	NO	OK	OK	OK	OK
Ethyl Acetate	NO	NO	NO	NO	OK	NO	NO	NO	NO	NO	NO	NO	NO
Ethylene Glycol	NO	NO	OK	OK	OK	NO	SOME	OK	OK	NO	OK	NO	NO
Formic Acid	NO	NO	NO	NO	OK	NO	NO	SOME	SOME	NO	NO	NO	NO
Fuel Oils	SOME	SOME	NO	NO	OK	SOME	SOME	NO	OK	SOME	SOME	OK	OK
Gasoline	NO	NO	NO	NO	NO	NO	OK	SOME	NO	NO	NO	OK	OK
Glycerin	NO	NO	OK	OK	OK	NO	SOME	OK	OK	NO	NO	NO	NO
Hydrochloric Acid, to 37%	NO	NO	NO	NO	NO	NO	NO	NO	NO	NO	NO	NO	NO
Hydrochloric Acid, to 50%	NO	NO	NO	NO	NO	NO	NO	NO	NO	NO	NO	NO	NO
Hydrogen Peroxide, to 30%	NO	NO	NO	NO	NO	NO	NO	SOME	NO	NO	NO	NO	NO
Jet Fuel(JP3, JP4, JP5)	NO	NO	NO	NO	OK	NO	SOME	NO	OK	NO	NO	OK	OK
Kerosene	OK	OK	NO	NO	OK	OK	OK	NO	NO	OK	OK	OK	OK
Lacquers	NO	NO	NO	NO	OK	NO	NO	NO	NO	NO	NO	NO	NO
Lacquer Thinners	NO	NO	NO	NO	OK	NO	NO	NO	NO	NO	NO	NO	NO
Lactic Acid	NO	NO	SOME	SOME	SOME	NO	NO	SOME	OK	NO	NO	NO	NO
Methyl Ethyl Ketone	NO	NO	NO	NO	OK	NO	NO	NO	NO	NO	NO	NO	NO
Mineral Spirits	NO	NO	NO	NO	OK	NO	NO	NO	NO	NO	OK	OK	OK
Naphtha	NO	NO	NO	NO	NO	NO	NO	NO	OK	NO	NO	OK	OK
Nitric Acid, to 20%	NO	NO	NO	NO	NO	NO	NO	SOME	SOME	NO	NO	NO	NO
Oxalic Acid, (Cold)	NO	NO	SOME	NO	NO	NO	NO	SOME	OK	NO	NO	NO	NO
Phosphoric Acid, to 40% solution	NO	NO	NO	NO	NO	NO	NO	SOME	OK	NO	NO	NO	NO
Photographic(developer)	NO	NO	SOME	SOME	NO	NO	NO	SOME	NO	NO	NO	NO	NO
Potassium Chloride	NO	NO	SOME	SOME	NO	NO	SOME	SOME	OK	NO	NO	NO	NO
Potassium Hydroxide	NO	NO	NO	NO	OK	NO	NO	NO	NO	NO	NO	NO	NO
Propylene Glycol	NO	NO	SOME	SOME	SOME	NO	NO	SOME	NO	NO	SOME	OK	OK
Silicone	OK	OK	OK	OK	OK	OK	OK	OK	OK	OK	OK	OK	NO
Sodium Bicarbonate	NO	NO	SOME	SOME	OK	NO	SOME	OK	OK	NO	NO	SOME	SOME
Sodium Chloride	NO	NO	SOME	SOME	OK	NO	NO	SOME	OK	NO	NO	NO	NO
Sodium Hydroxide 50%	NO	NO	NO	NO	SOME	NO	NO	NO	NO	NO	NO	NO	NO
Sodium Hypochlorite < 20%	NO	NO	NO	NO	NO	NO	NO	NO	NO	NO	NO	NO	NO
Sodium Nitrate	NO	NO	NO	SOME	OK	NO	NO	NO	OK	NO	NO	OK	OK
Sodium Sulfate	SOME	SOME	SOME	SOME	OK	NO	NO	SOME	OK	SOME	SOME	OK	OK
Stoddard Solvent	SOME	SOME	NO	NO	OK	NO	NO	NO	SOME	SOME	SOME	NO	NO
Sulfuric Acid, 75%	NO	NO	NO	NO	NO	NO	NO	NO	SOME	NO	NO	NO	NO
Toluene, Toluol	NO	NO	NO	NO	SOME	NO	NO	NO	SOME	NO	SOME	NO	NO
Trichlorethane	NO	NO	NO	NO	SOME	NO	NO	NO	NO	NO	SOME	NO	NO
Trichlorethylene	NO	NO	NO	NO	SOME	NO	NO	NO	SOME	NO	SOME	NO	NO
Turpentine	NO	NO	NO	NO	SOME	NO	NO	NO	NO	NO	SOME	NO	NO
Xylene	NO	NO	NO	NO	OK	NO	NO	NO	OK	NO	SOME	NO	NO

American Forge & Foundry offers a wide array of powerful merchandising displays and point-of-purchase assortments to help maximize sales and product awareness.

## AXLE NUT SOCKET DISPLAYS

6 AND 8 PT MIXED ASSORTMENT  
MODEL 18500P

6 AND 8 PT BOARD ONLY  
MODEL 18499A



- Display includes a mix of the most popular 6 and 8 pt sockets on one board
- Includes peg hooks and hardware for easy wall mounting
- No up-charge for display. Ships FREE with product.
- Includes 2 sockets of each size
- Each socket individually boxed and labeled for easy picking
- Dimensions: 30.5" high x 24" wide

MODEL	Description	MODEL	Description
18504	2-9/16" (6pt.)	18520	2-1/4" (6pt.)
18508	3-1/4" (6pt.)	18521	2-1/2" (6pt.)
18509	3-1/4" (8pt.)	18522	2-5/8" (6pt.)
18510	3-1/2" (6pt.)	18523	2-3/4" (6pt.)
18512	3-7/8" (6pt.)	18525	3-3/4" (8pt.)
18513	3-7/8" (8pt.)	18526	3-3/4" (6pt.)
18514	4" (6pt.)	18527	3-13/16" (8pt.)
18515	4-1/8" (6pt.)	18528	2-9/16" (6pt.)
18519	4-7/8" (8pt.)	18532	2-7/8" (6pt.)



**6 PT AXLE NUT SOCKET DISPLAY**

**MODEL 18560P**

MODEL	Description
18501	2-3/32" LOCKNUT SOCKET 6 POINT
18502	2-3/8" LOCKNUT SOCKET 6 POINT
18504	2-9/16" LOCKNUT SOCKET 6 POINT
18506	3" LOCKNUT SOCKET 6 POINT
18508	3-1/4" LOCKNUT SOCKET 6 POINT
18510	3 1/2" LOCKNUT SOCKET 6 POINT
18512	3 7/8" LOCKNUT SOCKET 6 POINT
18514	4" LOCKNUT SOCKET 6 POINT
18515	4-1/8" LOCKNUT SOCKET 6 POINT
18516	4-3/8" LOCKNUT SOCKET 6 POINT
18518	4-7/8" LOCKNUT SOCKET 6 POINT
18520	2-1/4" LOCKNUT SOCKET 6 POINT
18521	2-1/2" LOCKNUT SOCKET 6 POINT
18522	2-5/8" LOCKNUT SOCKET 6 POINT
18523	2-3/4" LOCKNUT SOCKET 6 POINT
18526	3-3/4" LOCKNUT SOCKET 6 POINT
18528	2-9/16" LOCKNUT SOCKET 6 POINT ROUNDED
18532	2-7/8" LOCKNUT SOCKET 6 POINT
18534	3-1/8" LOCKNUT SOCKET 6 POINT
18536	2-3/8" LOCKNUT SOCKET 6 POINT ROUNDED
18539	5-1/4" LOCKNUT SOCKET 6 POINT
18560A	DISPLAY BOARD

18560P 6PT kit includes 2 each



- Displays includes all industry standard 6 pt (18560P) or 8 pt (18580P) sockets
- Includes peg hooks and hardware for easy wall mounting
- No up-charge for display. Ships FREE with product.
- Empty display boards can be purchased separately
- Display dimensions: 30.5" high x 24" wide

**8 PT AXLE NUT SOCKET DISPLAY**

**MODEL 18580P**

MODEL	Description
18503	2-3/8" LOCKNUT SOCKET 8 POINT
18505	2-9/16" LOCKNUT SOCKET 8 POINT
18507	3" LOCKNUT SOCKET 8 POINT
18509	3-1/4" LOCKNUT SOCKET 8 POINT
18511	3-1/2" LOCKNUT SOCKET 8 POINT
18513	3-7/8" LOCKNUT SOCKET 8 POINT
18517	4-3/8" LOCKNUT SOCKET 8 POINT
18519	4-7/8" LOCKNUT SOCKET 8 POINT
18524	3-3/8" LOCKNUT SOCKET 8 POINT
18525	3-3/4" LOCKNUT SOCKET 8 POINT
18527	3-3/16" LOCKNUT SOCKET 8 POINT
18533	2-7/8" LOCKNUT SOCKET 8 POINT
18535	3-1/8" LOCKNUT SOCKET 8 POINT
18537	2-3/4" LOCKNUT SOCKET 8 POINT
18538	4-1/2" LOCKNUT SOCKET 8 POINT
18540	4-1/8" LOCKNUT SOCKET 8 POINT
18541	4-13/16" LOCKNUT SOCKET 8 POINT
18580A	DISPLAY BOARD

18580P 8PT kit includes 2 each of:



**6 PT AND 8 PT MIXED AXLE NUT SOCKET SHOP DISPLAY**

**MODEL 18501P**

MODEL	18501P Package
18504	2-9/16" LOCKOUT SOCKET 6 POINT
18508	3-1/4" LOCKOUT SOCKET 6 POINT
18509	3-1/4" LOCKOUT SOCKET 8 POINT
18510	3-1/2" LOCKOUT SOCKET 6 POINT
18512	3-7/8" LOCKOUT SOCKET 6 POINT
18513	3-7/8" LOCKOUT SOCKET 8 POINT
18514	4" LOCKOUT SOCKET 6 POINT
18515	4-1/8" LOCKOUT SOCKET 6 POINT
18519	4-7/8" LOCKOUT SOCKET 8 POINT
18520	2-1/4" LOCKOUT SOCKET 6 POINT
18521	2-1/2" LOCKOUT SOCKET 6 POINT
18522	2-5/8" LOCKOUT SOCKET 6 POINT
18523	2-3/4" LOCKOUT SOCKET 6 POINT
18525	3-3/4" LOCKOUT SOCKET 8 POINT
18526	3-3/4" LOCKOUT SOCKET 6 POINT
18527	3-3/16" LOCKOUT SOCKET 8 POINT
18528	2-9/16" LOCKOUT SOCKET 6 POINT ROUNDED
18532	2-7/8" LOCKOUT SOCKET 6 POINT
18497A	GRAPHIC OVERLAY KIT

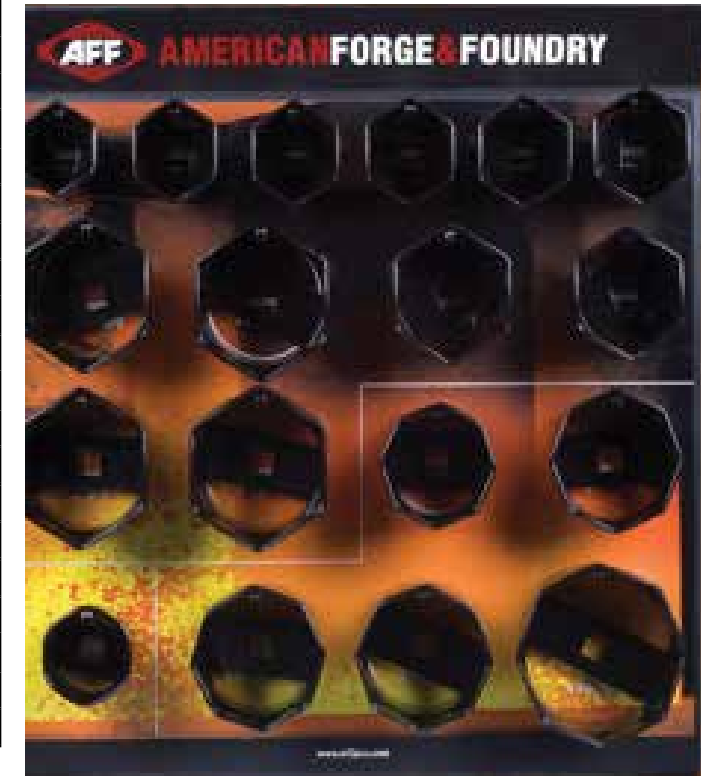

**VINYL GRAPHIC KIT ONLY**

**MODEL 18497A**



- Created with the end user customer in mind this display is great for Fleet, Heavy Duty, and Automotive shops
- Display includes 1 each of the most popular 6 and 8 pt sizes
- Puts sockets in plain view and within easy reach
- Display attaches to a pegboard wall in minutes
- Includes FREE graphics and hardware
- Dimensions: 30.5" high x 24" wide



**GREASE GUN DISPLAY  
MODEL 8901**



**8901 Grease Gun display includes:**

- (2) 8000 professional grease gun
- (4) 8003 pistol grip grease gun
- (2) 8006 suction gun
- (2) 8031 grease gun holder
- (1) 8900A grease gun display board

**GREASE GUN DISPLAY - BOARD ONLY  
MODEL 8900A**

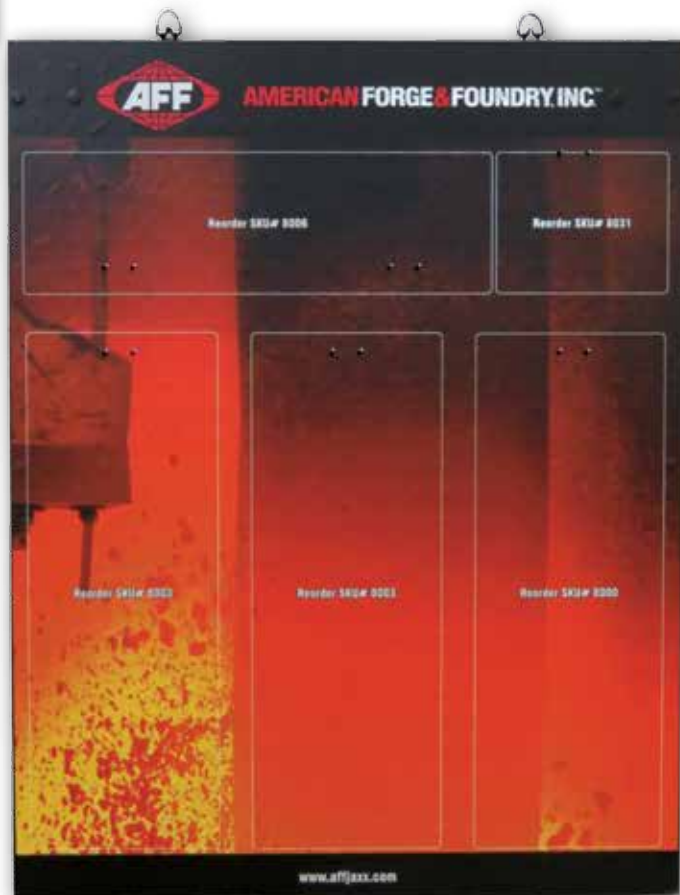

- Includes the most popular grease guns
- Display is free with product purchase
- Comes preassembled with peg hooks and easy instructions
- Dimensions: 30-1/4" high x 24" wide

**LUBE ACCESSORY DISPLAY  
MODEL 8903**



**8903 Lube Accessory display includes:**

- (2) 8012 12" whip hose
- (2) 8013 12" whip hose with spring
- (2) 8018 18" whip hose
- (2) 8019 18" whip hose with spring
- (2) 8021 90 degree adapter
- (2) 8022 1-1/2" needle adapter, narrow
- (2) 8023 4" needle adapter
- (2) 8025 recessed adapter
- (2) 8026 bulk loader valve
- (2) 8027 1-1/2" needle adapter
- (2) 8028 5/8" needle adapter
- (2) 8029 6" needle adapter
- (2) 8032 coupler
- (2) 8033 heavy duty coupler
- (2) 8034 right angle coupler
- (2) 8035 swivel coupler
- (2) 8037 seal off dispenser
- (1) 8902A lube display board

**LUBE ACCESSORY DISPLAY - BOARD ONLY  
MODEL 8902A**



- Includes a popular assortment of couplers, hoses, and adapters
- Display is free with product purchase
- Comes preassembled with peg hooks and easy instructions
- Dimensions: 30-1/4" high x 24" wide





**PUMP RACK DISPLAY**

**MODEL 8904D1**

- Attractively displays 8 of the best selling AFF pumps
- Part Number 8904D1 includes 2 each of the following skus:
  - 8055 Lever Action Barrel Pump
  - 8060 E-Z Flow 5 Gallon Oil Pump
  - 8064 Chemical Pump Nylon Body
  - 8070 Hand Rotary Diesel Pump
  - 8075 Polypropylene Rotary Barrel Pump
  - 8076 Polypropylene Rotary Barrel DEF Pump
  - 8080 Lever Action Barrel Pump for Gas/Diesel
  - 8081 Lever Action Antifreeze Barrel Pump
- Smaller footprint takes up less space than conventional displays (72" L x 21" W x 21" D)
- Want to customize? Order Part Number 8904 for the Display Only
- Literature rack included for AFF catalogs

**PUMP RACK DISPLAY ONLY**

**MODEL 8904**



**INVINCIBLE HAMMER DISPLAY**

**MODEL 50999**

- All steel construction with powder coat finish
- Sets up in minutes
- Display can hold up to 16 Invincible Handle Hammers
- Model 509D1 preset display includes "1" each of the following:
  - 50100 Club Hammer
  - 50105 Club Hammer
  - 50110 Club Hammer
  - 50210 Sledge Hammer
  - 50220 Sledge Hammer
  - 50230 Sledge Hammer
  - 50300 Ball Pein Hammer
  - 50400 Cross Pein Hammer
- Want to customize? Order a combination of 8 different hammers and receive Model 50999 for free



Product Number	Type	Head Weight (lbs)	Product Weight (lbs)	Handle Length (inches)
50100	Club	2.50	3.85	12
50105	Club	4.00	5.25	12
50107	Copper Club	4.00	5.75	12
50110	Club	4.00	5.75	16
50206	Sledge	6.00	8.70	16
50208	Sledge	8.00	10.00	16
50210	Sledge	8.00	11.10	24
50217	Copper Sledge	8.00	11.50	24
50220	Sledge	8.00	12.00	30
50222	Sledge	8.00	13.00	36
50224	Sledge	12.00	17.50	36
50230	Sledge	14.00	18.50	30
50237	Copper Sledge	14.00	18.20	30
50300	Ball Pein	2.50	2.90	16
50400	Cross Pein	3.50	5.10	16





## 4-Shelf Vertical Display

### MODELS 399, 399D1, 399D2, 399D3

- Heavy Duty display features diamond plate steel and a durable powder coat finish
- Contact an AFF sales representative to create a display to fit your market needs
- Ideal for small ton to medium ton bottle jacks, foot pumps, and vises
- Display ships FREE when purchased with product
- Display dimensions: 44-1/2"L x 24"W x 9-1/2"D

MODEL 399



MODEL 399D1



MODEL 399D2



MODEL 399D3



#### 399D1 Includes:

- 2 ea - 3502
- 2 ea - 3504
- 2 ea - 3506
- 2 ea - 3508
- 1 ea - 3514
- 2 ea - 3512
- 1 ea - 3522
- 1 ea - 3520

#### 399D2 Includes:

- 1 ea - 30510
- 1 ea - 3944
- 1 ea - 3948
- 1 ea - 3522
- 1 ea - 3520

#### 399D3 Includes:

- 2 ea - 8040
- 2 ea - 8042
- 1 ea - 8043
- 2 ea - 8044
- 2 ea - 8041
- 1 ea - 3504
- 1 ea - 3506
- 1 ea - 3508
- 1 ea - 3512
- 1 ea - 3522
- 1 ea - 3520



## 4-Shelf Waterfall Display

### MODELS DISPLAY-350A, 350D1, 350D2

- Heavy Duty display features diamond plate steel and a durable powder coat finish
- Contact an AFF sales representative to create a display to fit your market needs
- Ideal for floor jacks, safety stands, large ton bottle jacks, and hose reels
- Display ships FREE when purchased with product
- Display dimensions: 64-1/2"L x 26"W x 43-1/2"D
- 120 lb weight capacity per shelf



MODEL DISPLAY-350A

MODEL 350D1



#### 350D1 Includes:

- 1 ea - 3502
- 1 ea - 3504
- 1 ea - 3506
- 1 ea - 3512
- 1 ea - 3514
- 1 ea - 3522
- 1 ea - 3520
- 1 ea - 200T
- 1 ea - 350SS

MODEL 350D2



#### 350D2 Includes

- 1 ea - 3502
- 1 ea - 3504
- 1 ea - 3506
- 1 ea - 3508
- 1 ea - 3514
- 1 ea - 3506C
- 1 ea - 3512
- 1 ea - 3522
- 1 ea - 3520
- 1 ea - 3530
- 1 ea - 3550







**MODEL NUMBER INDEX**

4KR20	34	812-41	35	3181	18	3752	22
4KR21	34	814-40	34	3182	19	3753	22
4KR22	34	814-41	35	3198	18	3900A	50
200T	4	814C	33	3220	11	3901	45
200TK40	9	815-40	34	3225	11	3902	45
200TK42	9	815-41	35	3233A	30	3904	40
202T	4	815C	33	3303	29	3905	43
206	8	818SD	33	3306	29	3906	42
208	8	818SD-40	33	3305A	29	3907	42
210	8	818SD-41	33	3309A	28	3908	43
300LR	5	820A	39	3310A	28	3909	43
300T	6	820AK7	39	3311	29	3910	43
302T	6	832A	38	3312B	29	3911A	32
320SS	5	832AK12	39	3314	28	3912A	32
322SS	5	834	38	3315A	30	3917	23
350A	86	837	38	3318	30	3941	41
350D1	87	850ASD	37	3320A	30	3942	41
350D2	87	850ASD-P	39	3322	88	3943	41
350GTK23	9	852ASD	37	3340SD	31	3944	41
350GTK41	9	852ASD-P	39	3342SD	31	3947	41
350SS	6	854ASD	37	3344SD	31	3948	41
350SSK24	9	854ASD-P	39	3400A	27	4001	51
352SS	7	856ASD	37	3420ASD	31	4002	51
352SSK24	9	856ASD-P	39	3502	26	4003	51
390	9	859ASD	37	3504	26	4005	51
399	84	859ASD-P	39	3506	26	4008	51
399D1	84	862ASD	36	3506C	26	5512B	26
399D2	85	920	61	3508	26	5520B	26
399D3	85	921	61	3512	26	5612SD	24
400SS	7	961	45	3514	26	5620SD	24
535A	12	962	45	3520	26	5621SD	24
536	13	963	45	3522	26	5630SD	24
545SD	20	964	45	3530	26	7010	63
546SD	20	990	40	3550	26	7020	63
547SD	21	992	40	3577	32	7100	65
548SD	21	994	40	3582	46	7150	64
549SD	21	2145A	16	3584	46	7151	64
551	13	2158	16	3586B	47	7160	64
565E	12	3001	88	3590A	32	7161	65
565E-HANDLE	12	3003	88	3591	32	7162	65
565E1	12	3040A	23	3595A	32	7660	62
571B	48	3052	14	3596	27	7665	62
573B	48	3052A	14	3598	27	7670	62
582	47	3102	15	3602	25	7685	63
583	47	3102A	15	3604	25	8000	67
584	47	3120	10	3606	25	8002	67
760	45	3125	10	3608	25	8003	67
761	45	3130	10	3612	25	8004	67
804-09	34	3135	11	3612S	25	8005	68
804-10	35	3160	16	3620	25	8006	67
804-11	35	3165	9	3620S	25	8007	68
805	34	3167	9	3630	25	8010	68
806	34	3171	17	3650	25	8012	69
810-07B	35	3172	17	3700	22	8013	69
810-41	35	3178	17	3749	22	8014	69
810-45	35	3180A	18	3751	22	8018	69

**MODEL NUMBER INDEX. Cont'd**

8019	69	8686	69	18536	60	50505	53
8021	69	8687	69	18537	60	50506	53
8022	69	8698	69	18538	60	50601	53
8023	70	8815	73	18539	60	50999	83
8024	70	8830	75	18540	60	57000	60
8025	70	8831	75	18541	60	57001	60
8026	70	8870	74	18560P	78	57002	60
8027	70	8874	74	18580P	78	57003	60
8028	70	8877	73	30200	51	58001	58
8029	70	8878	73	30400	51	58002	58
8033	70	8879	73	31200B	44	58003	58
8030	70	8888	74	31350B	44	58004	58
8031	70	8890	74	31400B	44	58005	58
8032	70	8890K08	74	31500	42	AFFBUCKET	61
8034	70	8893	75	31501	42	LRC3B	35
8035	70	8895	75	31510	42	LRC8B	35
8036	70	8900A	80	31520	42	PWBRUSH	44
8037	70	8901	80	40012	54		
8038	72	8902A	81	40200	54		
8039	72	8903	81	40300	55		
8040	68	8904	82	40400	55		
8041	68	8904D1	82	40405	56		
8042	68	18497A	79	41050	57		
8043	68	18499A	77	41051	57		
8044	68	18500P	77	41052	57		
8050	73	18501	60	41053	57		
8051	73	18501P	79	41054	57		
8055	71	18502	60	41055	57		
8060	71	18503	60	42005	58		
8064	71	18504	60	42015	58		
8070	71	18505	60	42005	58		
8071	71	18506	60	42065	59		
8075	71	18508	60	42080	59		
8076	72	18509	60	42100	59		
8077	72	18510	60	42120	59		
8080	72	18511	60	42140	59		
8081	72	18512	60	50100	52		
8090	69	18513	60	50105	52		
8091	70	18514	60	50107	52		
8100	69	18515	60	50110	52		
8103	68	18516	60	50206	52		
8104	68	18517	60	50208	52		
8210	72	18518	60	50210	52		
8600A	66	18519	60	50217	52		
8600AP	66	18520	60	50220	52		
8605	67	18521	60	50222	52		
8612	69	18522	60	50224	52		
8618	69	18523	60	50230	56		
8620A	66	18524	60	50237	52		
8620AP	66	18525	60	50300	52		
8621A	66	18526	60	50400	52		
8622A	66	18527	60	50500	53		
8625	49	18528	60	50501	53		
8654	50	18532	60	50502	53		
8655	49	18534	60	50503	53		
8656	49	18535	60	50504	53		





**SureWerx™**

**300 Corporate Drive**

**Elgin, IL 60123**

**Phone: 800-323-7402**

**Fax: 847-717-8419**

**[orders.usa@surewerx.com](mailto:orders.usa@surewerx.com)**

**[www.affjaxx.com](http://www.affjaxx.com)**

**[www.surewerx.com](http://www.surewerx.com)**